

EXERCISE 8

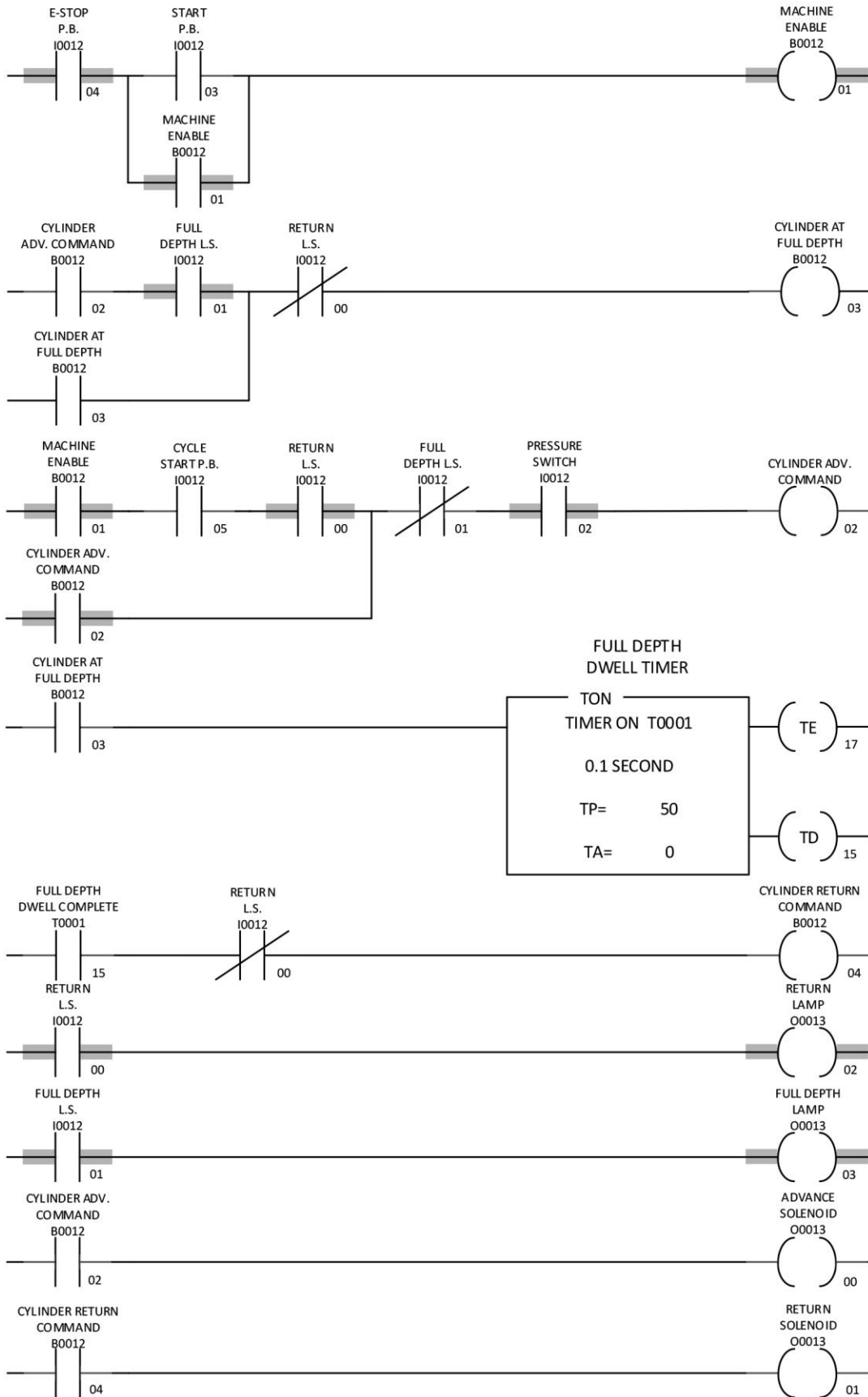

SAFETY DISCLAIMER:

M-SAMC educational resources are in no way meant to be a substitute for occupational safety and health standards. No guarantee is made to resource thoroughness, statutory or regulatory compliance, and related media may depict situations that are not in compliance with OSHA and other safety requirements. It is the responsibility of educators/employers and their students/employees, or anybody using our resources, to comply fully with all pertinent OSHA, and any other, rules and regulations in any jurisdiction in which they learn/work. M-SAMC will not be liable for any damages or other claims and demands arising out of the use of these educational resources. By using these resources, the user releases the Multi-State Advanced Manufacturing Consortium and participating educational institutions and their respective Boards, individual trustees, employees, contractors, and sub-contractors from any liability for injuries resulting from the use of the educational resources.

DOL DISCLAIMER:

This product was funded by a grant awarded by the U.S. Department of Labor's Employment and Training Administration. The product was created by the grantee and does not necessarily reflect the official position of the U.S. Department of Labor. The Department of Labor makes no guarantees, warranties, or assurances of any kind, express or implied, with respect to such information, including any information on linked sites and including, but not limited to, accuracy of the information or its completeness, timeliness, usefulness, adequacy, continued availability, or ownership.

RELEVANCY REMINDER:

M-SAMC resources reflect a shared understanding of grant partners at the time of development. In keeping with our industry and college partner requirements, our products are continuously improved. Updated versions of our work can be found here: <http://www.msamc.org/resources.html>.

