



Jones

English

English Avenue

FC2

FLOURISHING COMMUNITIES COLLABORATIVE

Westside Neighborhood - English Avenue:
Building a Sustainable Community through Design and Technology

DESIGN TECHNOLOGY MANUAL

In Collaboration with the Georgia Institute of Technology
College of Design, School of Architecture

FLOURISHING COMMUNITIES COLLABORATIVE

Georgia Institute of Technology
College of Design, School of Architecture - 2022

This course is a Flourishing Communities project. Rooted by goals of building equitable, just, and inclusive environments, Flourishing Communities Collaborative (FC2) provides the opportunity for teaching, scholarship, practice, and service in solidarity, informed by the social, technological, and environmental priorities of our institution.

FC2 partners students and practitioners with community groups in need of project assistance, teaching design methodologies and enabling the groups to apply design thinking to their process in pursuit of solving problems. Based on the idea of a teaching hospital, FC2 combines design, technology, and entrepreneurship through applied skills to test an innovative educational model. FC2 operates in the common ground between the academy and practice, building connections between the community, practitioners, and students.

We are committed and motivated to increase access to food and water, to energy, education, and healthcare, retail, and affordable housing through actionable, equitable, and creative design proposals and actionable strategies for implementation.

Aligned with Georgia Tech's motto, Progress and Service, we are invested in establishing a sustainable and innovative educational model that builds the capacity of our students to effect positive impact on our local communities. Flourishing Communities Collaborative is the bridge that connects the academy, practice, and the community. We support the idea that people are key operators in inspiring and creating new ecological, equitable, and flourishing urban environments and spaces.

For the students, FC2 is driven by these questions:

- How might we best prepare students to apply inventive approaches to problem finding and problem solving across scales and disciplines?
- How might we engage our students in socially significant work?
- What is the value of building connections between students and practitioners who can model best practices in communication, collaboration, and design thinking?

Flourishing Communities Collaborative

Westside Neighborhood – English Avenue
Building a Sustainable Community through Design and Technology
ARCH 8833

Georgia Institute of Technology

College of Design
School of Architecture
245 4th St NW
Atlanta, GA 30332

Faculty Advisor

Julie Kim, Associate Professor and
Director, Flourishing Communities
Collaborative, Georgia Tech

Students

Weston Byerly
Luke Davis
Patricia Alejandra del Moral-Suazo
Charles Dilcher
Milamem Lauriane Donang
Robert Feagans
Keyhan Khaki
Minji Kim
Palav Patel
Patricia Rangel
Breanna Rhoden
Eden Wright

Graduate Research Assistants

Ranjitha Jayasimharao
Breck Small

Contributors

John Ahmann, President & CEO,
Westside Future Fund

Richard Alsop, Managing Principal, HDR
Architecture

William R. Bryant, Jr., Landscape Architect
and Planning Section Manager, HDR
Architecture

Jessica Flake, Architect, HDR Architecture

Lee Harrop, Westside Future Fund

Tarek Rakha, PhD, Assistant Professor,
School of Architecture, Georgia Tech

Michael Street, HDR Architecture

Winston Taylor, The Beloved Community,
Inc.

Danielle S. Willkens, PhD, Assistant
Professor, School of Architecture,
Georgia Tech

ACKNOWLEDGMENTS

The work included in this booklet represents just a piece of a larger effort that started in Summer 2021.

We are grateful for the support of all of the individuals who contributed to this specific project. We want to thank the Public Interest Technology - University Network whose support has helped make this project possible. This is a multi-year effort and we are also grateful for the College of Design and the School of Architecture at Georgia Tech for their support of our efforts.

Special thanks to John Ahmann at Westside Future Fund for his commitment to this community, and to Lee Harrop, Westside Future Fund; Matt Maxwell, OaksATL; Michael Street, HDR Architecture; Robby Bryant, HDR Architecture; Jessica Flake, studioSOGO; and Jennifer Fine, Invest Atlanta, for their unflagging support and continuous engagement with us. We would be remiss if we did not also recognize Winston Taylor, The Beloved Community, for his enthusiastic commitment to our efforts.

Finally, special thanks to all of the students, my faculty colleagues, and our graduate research assistants! I could not have done this without you - and am happy we were on this journey together.

- Julie Ju-Youn Kim, Director, Flourishing Communities Collaborative

CONTENT SELECTION

MISSION



DESIGN TECHNOLOGY MANUAL

Mission Introduction	08
Historical Context	12
Neighborhood Context	14
Existing Conditions	16
Design Interventions	18
SIPs Systems	20
CLT Structure	40
Kit-of-Parts Design	50
Conclusion	58

ANALYSIS



SITE ANALYSIS MANUAL

Climate Analysis	00
Future Climate Projection	00
Design Guidelines	00

CASE STUDY



CASE STUDY MANUAL

Innovative Fabrication	04
Salvaged Material	34
Affordable Housing	46
Net-Zero Precedents	68



MISSION

Housed in the School of Architecture, College of Design, Flourishing Communities Collaborative(FC2) is modeled after a teaching hospital as an innovative curricular model that builds relationships between students, faculty, practitioners, and the community in applied design thinking and problem solving for under-served communities.

The work from this class supports a funded design and research project that addresses the socioeconomic and technical needs of Westside neighborhood English Avenue. This project leverages existing community resources to develop affordable housing and the establishment of positive neighborhood-based, citizen-centric social impact and equity through technology.

This project proposes tools and methods enabling under served communities to apply design thinking in pursuit of solving problems. We will prioritize the needs of the Westside Neighborhood English Avenue community by developing frameworks that support building social capital for the neighborhood.

We position the home as an essential instrument for daily life and community engagement. In this project we will employ design research methods including site analysis, schematic design, and performance simulation to empower a current resident with a new affordable home aimed at redefining resiliency and economic sustainability. This project maintains the current historic fabric of single-family homes, building equity for the residents. In a historically vibrant, but rapidly shrinking neighborhood, our work will bolster retention and help to stabilize the community.

We developed this manual for the design and construction for a single-family house prototype. The team will approach the project through three related considerations:

- 1) issues on community and identity,
- 2) advancements in technology and production, including evaluating opportunities for innovative fabrication/ assembly initiatives and for reuse-repurposing finite resources,
- 3) energy performance, resiliency, and sustainability.

OUR PROCESS

For a community to be flourishing and sustainable, there must be access to housing, education, health care, and jobs.

The most notable examples of similar successful community outreach and social engagement include Auburn University's Rural Studio, Tulane University's Small Center, the University of Kansas's Studio 804, and the Yale Building Studio at Yale University. Currently, there is not a similar, urban-based concept underway at a higher learning institution in the Southeast.

FC2 creates scalable and duplicable models that can be applied in multiple communities that includes people with different backgrounds, resources, and abilities. We empower through design by engaging communities who would not otherwise have access to technology, architecture, construction, or engineering. FC2 serves as a platform for cultivating careers in public interest and social engagement while ensuring our student pipeline includes diverse races, ethnicities, abilities, genders, and socioeconomic status. We provide community partners design methodologies and enable the application of design thinking to their problem-solving pursuits.

Our measure for success will be commitments from the community and the non-profit Westside Future Fund to work in collaboration with FC2 to propose solutions to identified needs.

By December 31, 2022, FC2 will have built an affordable, resilient home. In 2023, our scope will broaden to embodied energy: proposals for energy saving strategies for community residents. In 2024, our focus will expand to examine community-specific neighborhood systems. Our multi-year efforts will establish a clear road map for continued development and realization, enhancing shared values of the profession: design, equity, diversity, and inclusion, and community engagement.

Steps to Design

1

LISTEN - ASK - UNDERSTAND

Our primary goal is to listen to the needs of the community and seek first to understand.

2

ESTABLISH GIVENS

- The community lacks access to technology and resources to support entrepreneurial efforts.
- This is a historically vibrant but rapidly shrinking neighborhood.
- The median income for all households in the Westside is \$24,011, compared to \$46,631 for Atlanta as a whole; and nearly 80% of Westside households earn less than the median Atlanta household. The current residents have expertise and ambition that can be directed towards empowering the community members as agents of change.
- Investment in retrofitting and updating current housing is needed to build community retention.

3

RESEARCH

Through site and environmental analysis, and through careful precedent study and analysis, we determine possible frameworks to guide the design process.

4

DESIGN PROPOSAL

Propose design options that are sustainable, deeply affordable, and beautiful.

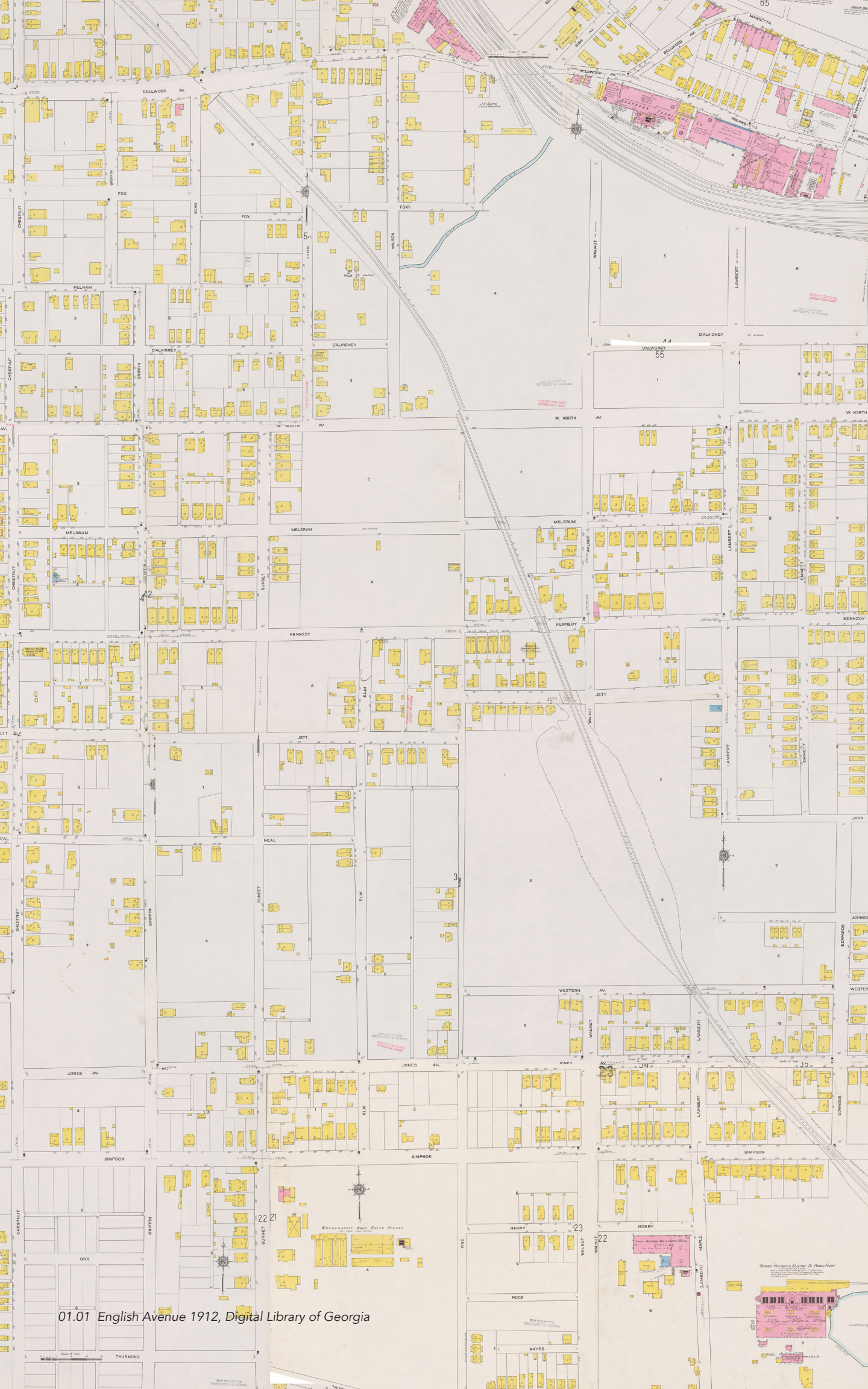

HISTORICAL CONTEXT

The English Avenue was first purchased in 1891 by James W. English Jr., son of the Atlanta Major. It was initially created to be a working-class white neighborhood and faced many evolutions of racial diversity over the proceeding 130 years.

After the 1917 fire and into the 1940s, the great need for housing brought a more diverse collection of residents. English Avenue and its southern border neighborhood, Vine City, enter its "hey-day" in the 1950s and 60s. The two neighborhoods became a hub for civil rights activists. Dr. Martin Luther King Jr. and his wife Coretta Scott King moved into English Avenue in 1967, joining the thriving community. Hunter Street that ran through the core of the neighborhood, named after one of the largest slave owners in the state, was renamed to Martin Luther King Drive in 1976 after the prominent resident.

Suburbanization started to show its effects in the 1970s when the area's population began to decline leaving large numbers of homes vacant. The boarded-up homes and empty lots provided a space for crime and drug dealing. English Avenue Elementary school followed by closing in 1995. The neighborhood now stands in a similar state with more abandoned houses than occupied ones.

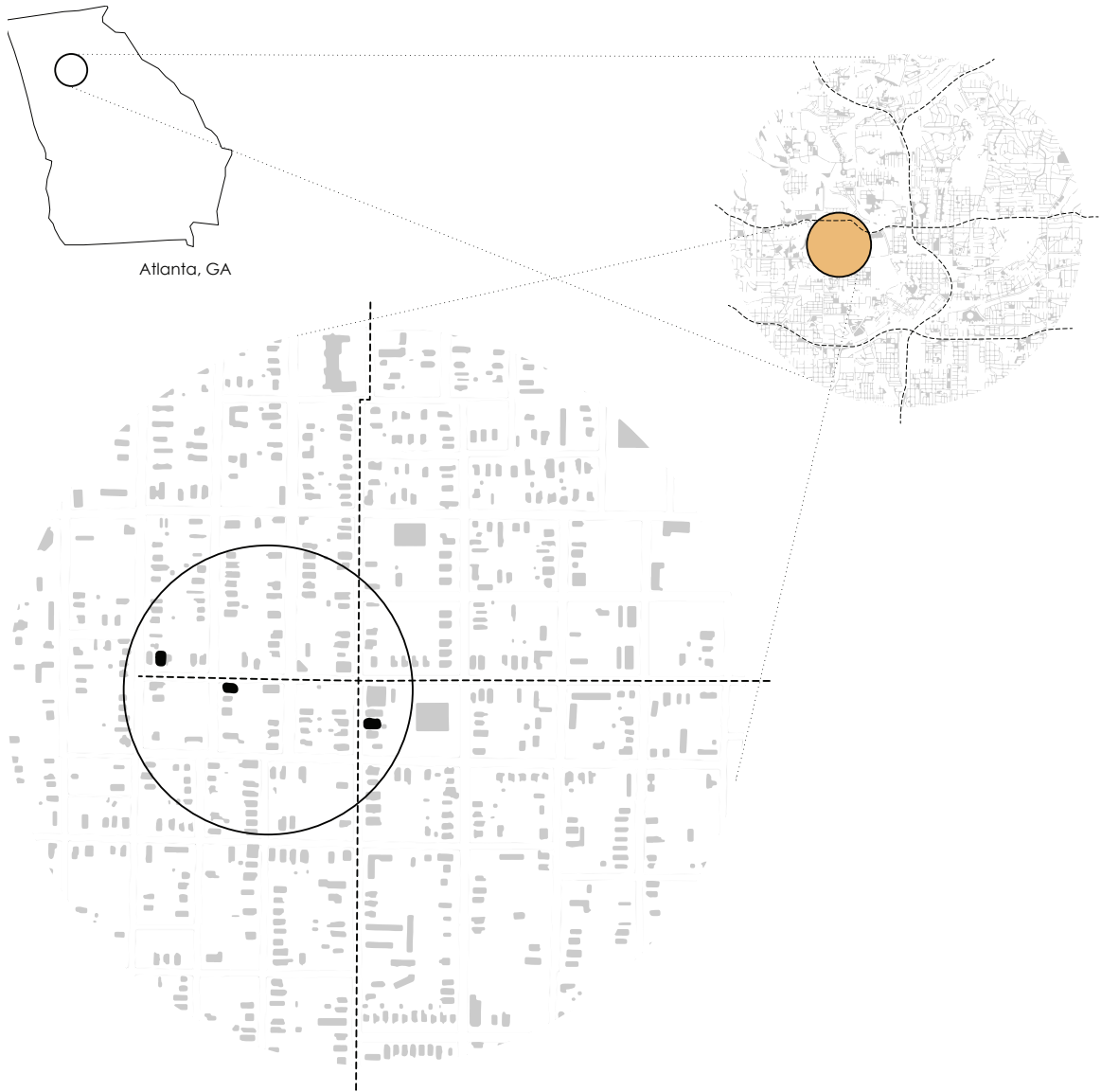

NEIGHBORHOOD CONTEXT

The English Avenue Neighborhood was originally created for white working-class families in the late 1800s. Serving as a racial buffer in Atlanta for over 100 years, English Avenue, as a neighborhood, has had a constant tension. As seen in today's context, there has been a continued debate between outside developers and long-time residents of the neighborhood, which creates other forms of tension as well. This tension within the neighborhood has resulted in neglect and has bred negative activities.

Recently, Westside Future Fund, a local non-profit organization, has taken initiative to rebuild the homes and restore the community. Partnering with Georgia Tech students and faculty, the neighborhood has been a priority and topic of conversation to think about the opportunities to revitalize and create a flourishing community.



01.05 Site Photos, English Avenue Neighborhood, GaTech

EXISTING CONDITIONS - SITE AND CONTEXT

The English Avenue Neighborhood lies in an interesting part of the city of Atlanta. Most of Westside Atlanta was originally used for industrial purposes, therefore the infrastructural needs, environmental conditions, and accessibility are all at a disadvantage in comparison to other parts of the city.

Most of the homes in this community and other neighboring areas are built fast and cheap, which results in poor insulation and vulnerable structural capabilities. Numerous examples of this home condition are present in the westside neighborhoods and are key components for how to design for the future of this neighborhood.

The zoning of the English Avenue Neighborhood also lies in a major watershed zone, especially in the south end of the community. Water has a tough time escaping into the drainage system due to the lack of infrastructural capabilities in the area. Homes in this area are thus prone to molding, flooding, and destruction due to this site condition.

Accessibility to healthcare facilities, everyday shopping needs, and green spaces are at a minimum as well. Integrated with designing at the residential scale, designing for these types of programs are other key programming components that help create a flourishing community.

EQUITY, DIVERSITY, AND INCLUSION

Technology is ubiquitous, yet we cannot presume it is equally accessible across all communities. Technology in smart homes and smart cities does not adequately address the needs of all communities, specifically those who are undeserved or under-resourced. However, if we draw upon the needs of the community leveraged with specific knowledge about the context, the technologies we will introduce and implement can be powerful tools that swing the needle in a positive direction.

Consider access and agency. This project asks:

- How can communities lacking capital for investment and various kinds of expertise be empowered as community builders?
- How can technology be used to build equity within established communities?
- What tools can we introduce to empower community agents through direct engagement of the processes of investment, design, and construction to realize a shared community vision?

Our immediate focus is on the English Avenue neighborhood. The efforts from this project proposal will positively impact the current 3,000+ residents of the English Avenue neighborhood.

In alignment with the goals stated in the 2017 Land-Use Framework plan, we will acknowledge and propose strategies to strengthen neighborhood assets while also reinforcing the neighborhood's unique identity.

FC2 pursues empowering through design by engaging communities and inspiring solutions for individuals who would not otherwise have access to innovative technology, architecture, urban design, construction, or engineering. Since 2017, we have worked with non-profit organizations and community groups, offering tools and methods enabling these undeserved communities to apply design thinking to projects in pursuit of solving problems. This project will allow FC2 to grow and increase exposure for our students with important and meaningful social outreach and engagement efforts, cultivating the next generation of citizen architects and community advocates who will create a more equitable built environment.

Rooted by goals of building equitable, just, and inclusive environments, FC2 provides the opportunity for teaching, scholarship, practice, and service in solidarity, informed by the social, technological, and environmental priorities of our institution. We are committed and motivated to increasing access to food and water, to energy, education, healthcare, retail, and affordable housing through actionable, equitable, and creative design proposals and actionable strategies for implementation. FC2 empowers through design by engaging communities. In alignment with the UN's Sustainable Development Goals, good design is a human right and should be accessible to all.

DESIGN INTERVENTIONS

Three design interventions to equip homeowners to design for their needs.

- 1 STRUCTURALLY INSULATED PANELS**
Panelized Systems for Main Structure
- 2 CROSS LAMINATED TIMBER**
Structural System and Interior Finishes
- 3 KIT-OF-PARTS DESIGN**
Personalized Design Options



02.01 SIP m3 House, Ian Hsu + Gabriel Rudolphy, 2014

STRUCTURALLY INSULATED PANELS

Panelized Systems for Main Structure

Structural insulated panels (SIPs) are tailor-made, flexible in design and benefit all parties. Few other products address budget, environment, resource, and fundamental housing concerns in a single package. SIPs distinguish themselves from other off-site construction techniques being engineered for strength allowing for open floor plans, architectural creativity and aesthetic appeal which make both professionals and homeowners proud.

- Less than 2% of homes being built today are constructed with SIPs.
- Ability to achieve high performance standards while considering environmental impact.
- Ease of construction when meeting building codes and maintaining a controlled indoor air quality.

Products such as SIPs are checking the boxes as a low embodied carbon material that creates a healthier living environment due to their airtight nature. They require less on site labor, and the structure is erected in a third or half the time of a conventional stick-frame project.

On average a SIP system project uses 70% less lumber than a conventionally built home, resulting in a more stable price point. Various life cycle analyses point to the positive environmental impact SIP designs achieve in reducing energy use and greenhouse gas emissions, beginning with requiring less lumber. Analyses also demonstrate that a SIP structure has a lower cost to occupy and own.

Benefits

- Active Surfaces
- Renewable Energy
- Healthy Air
- Bio-Diversity
- Temperature Regulation
- Bio-Composites

SIP SYSTEMS ADVANTAGES

From ZS2 Technologies, a southeast company



Safe

With traditional wood frame house, occupants have 3 minutes to safely evacuate. SIPs increase the evacuation time.



Economical

With the increase of labor and material cost, SIPs production mitigates the effects of fluctuating prices.



Sustainable

The construction industry is responsible for over 40% of global CO2 emissions. SIP production aims to reduce the amount of CO2 emission.

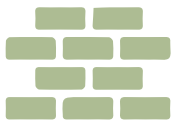

Resilient

Protect against weather-related disasters



Efficient

SIPs thermal design protects the building to excess amounts of heating and cooling loss.



Simple

Increase the amount of off-site production and reduce construction time.

SIP SYSTEMS - CURRENT MANUFACTURING

Manufacturing and Installation



San Diego, CA



Calgary, AB



Holland, MI



Albuquerque, NM



Bainbridge, GA



Alpharetta, GA



Hollister, CA



Marietta, GA

SIP SYSTEMS PRODUCTS

A local manufacturer & SIP system engineer, STO Corp, has been operating in Atlanta for over 15 years. They work in a variety of architectural disciplines such as

- Commercial/Mixed Use
- Multi Family Residential
- Single Family Residential

The following graphics are examples of the different systems which STO Corp has engineered and constructed.



02.04 IP System Building Examples

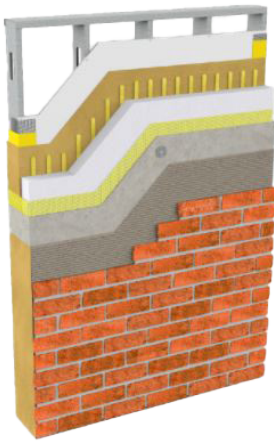

stocorp.com

StoPanel MVES

- Light weight 8-10 Pounds per Square foot (psf) plus up to 13 psf cladding weight
- Patented Sto Wedge Moisture Drainage Design
- StoGuard waterproof and moisture barrier
- Up to R-16 continuous insulation



stocorp.com

StoPanel Classic NExt ci

- Light weight 8-10 Pounds per Square foot (psf)
- Allows for drainage through weeps in Patented Sto Wedge Design
- Utilizes Sto Dual Seal Technology
- StoGuard continuous waterproof air barrier is a standard component

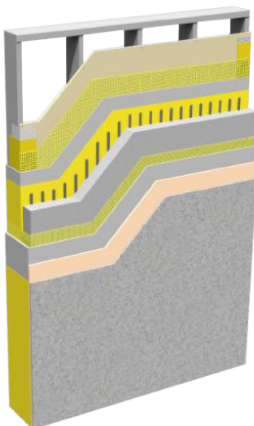

02.05 stocorp.com

StoPanel Impact ci

- 8-10 Pounds per Square foot (psf)
- Allows for drainage through weeps in Patented Sto Wedge
- Meets Large & Small Missile Impact Resistant criteria for Miami-Dade County and other High Velocity Hurricane Zones (HVHZ)
- StoGuard continuous waterproof air barrier is a standard component
- Continuous Insulation is a Standard Component
- Utilizes Sto Dual Seal Technology

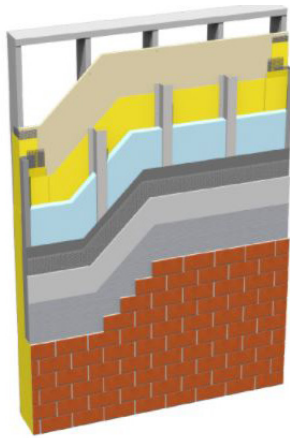

stocorp.com

StoPanel Brick ci

- Approx. 25 Pounds Per Square Foot (psf)
- Allows for drainage through weeps in Patented Sto Wedge Design
- Saves money on structural materials vz. Traditional brick
- Utilizes Sto Dual Seal Technology
- Continuous Insulation is a standard component
- StoGuard continuous waterproof air barrier is a standard component

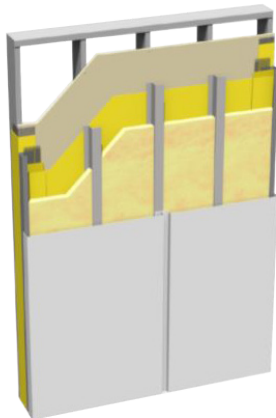

stocorp.com

StoPanel Metal ci

- Approx. 10 Pounds Per Square Foot (psf)
- StoGuard continuous waterproof air barrier is a standard component
- Utilizes Sto Dual Seal Technology
- Exterior insulation available as an option
- A variety of metal panels can be utilized

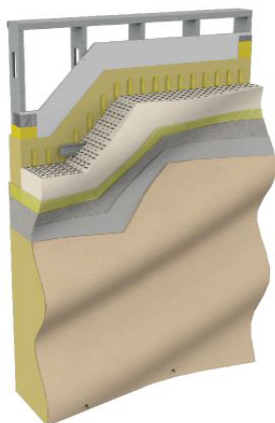

stocorp.com

StoPanel 3DP powered by Branch Technology

- Lightweight 3D printed polymer matrix
- Patented Sto Wedge moisture drainage design
- StoGuard waterproof air and moisture barrier
- Up to 10" of continuous insulation

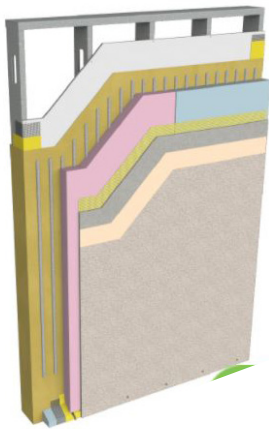

stocorp.com

StoPanel XPS ci

- 8-10 Pounds Per Square Foot (psf)
- Allows for drainage through weeps in Patented Sto Wedge Design
- Utilizes Dow Panel Core 20 for R-Value of 5.0 per 1" of continuous insulation
- Utilizes Sto Dual Seal Technology
- StoGuard continuous waterproof air barrier is a standard component
- Exceptional durability / compressive of 20 psi

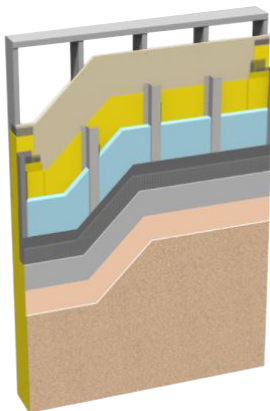

stocorp.com

StoPanel Precast ci

- Approx. 20 Pounds Per Square Foot (psf)
- Allows for drainage through weeps in Patented Sto Wedge Design
- Utilizes Sto Dual Seal Technology
- Saves money on structural materials vs. traditional precast concrete
- StoGuard continuous waterproof air barrier is a standard component
- Includes Sto Crack Defense System for added crack resistance



stocorp.com

StoPanel Backup

- Approx. 5 Pounds Per Square foot (psf) (minus cladding)
- StoGuard continuous waterproof air barrier is a standard component
- Utilizes Sto Dual Seal Technology
- Easy installation continuous exterior insulation over StoGuard
- Design Freedom with Multiple cladding options

DESIGN OF AFFORDABLE SIP SYSTEM

Salvaged / Recycled SIP system panels

A New Design for Affordable Sustainability, 479 James P Brawley Dr

Benefits

- Active Surfaces
- Renewable Energy
- Healthy Air
- Bio-Diversity
- Temperature Regulation
- Bio-Composites

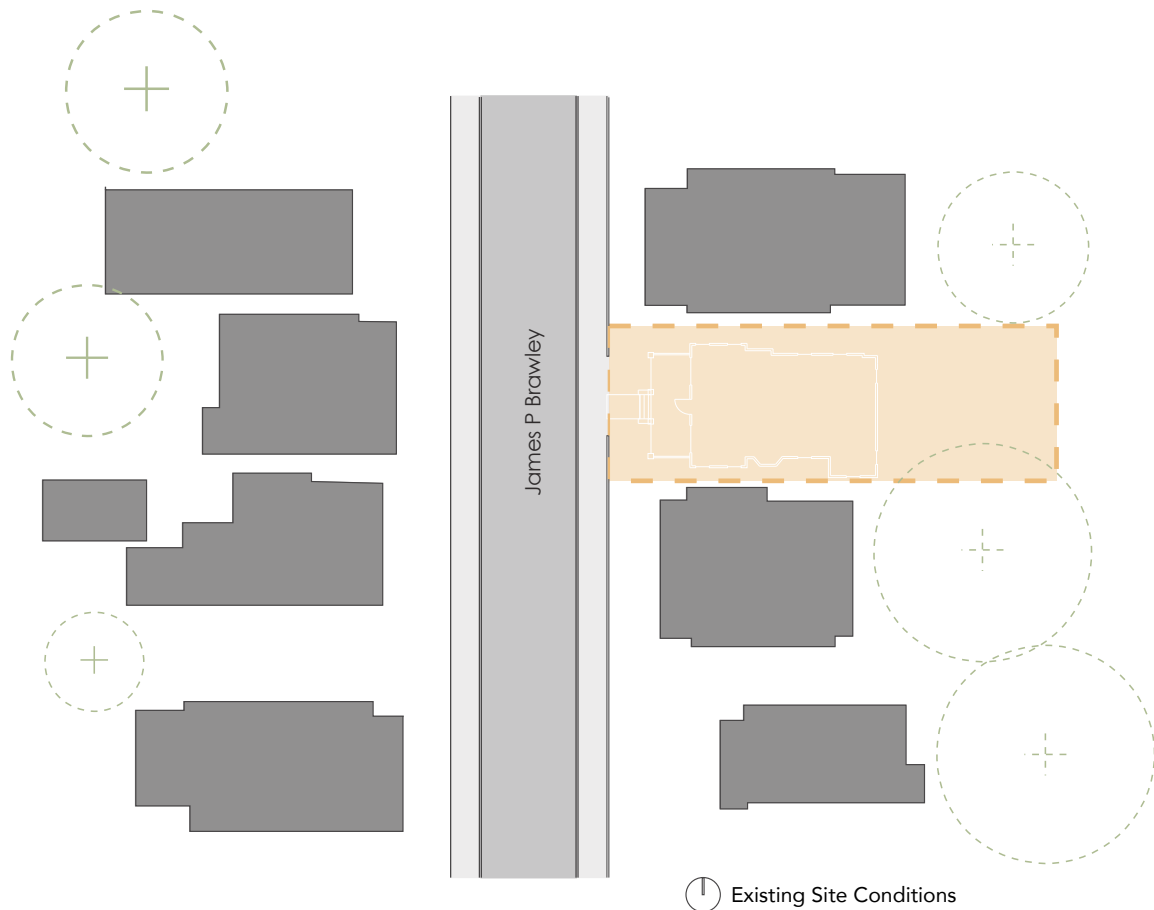

Exterior Joint

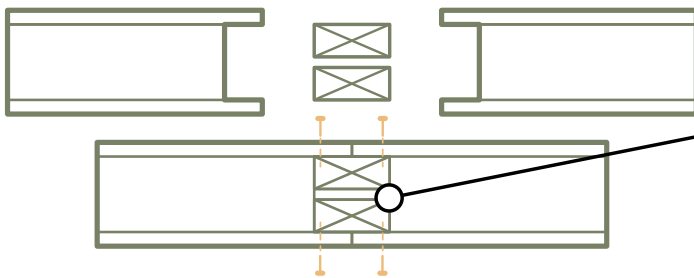

FULL JOINT 3.5" x 6"
Panel lip 1.75"

STANDARD
(3) nom. 2x4
(3) 1.5" x 3.5"
w/ 1.5" gap

CHANNEL
Faced w/ 3/4" ply
3.5" x 4.5" metal channel
Infill space 3" x 4"

INSULATOR
Faced w/ 3/4" ply
w/ 3.5" x 4.5" insul. block

Interior Joint

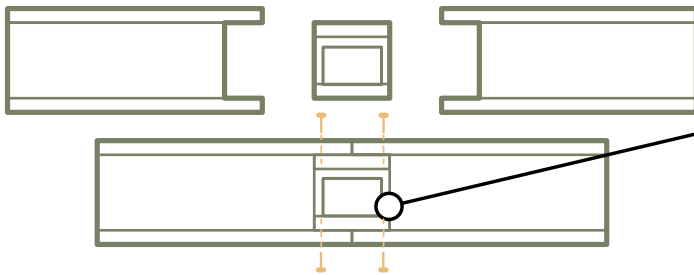

FULL JOINT 3.5" x 4"
Panel lip 1.75"

STANDARD
(2) nom. 2 x 4
(2) 1.5" x 3.5"
w/ 1" gap

CHANNEL
Faced w/ 3/4" ply
3.5" x 2.5" metal channel
Infill space 3" x 2"

INSULATOR
Faced w/ 3/4" ply
3.5" x 2.5" insul. block

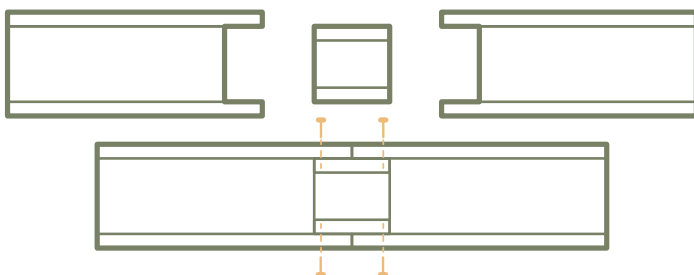

Joint Detail

Axon Legend

- 1 STANDARD FOOTER
2" x 4" nominal dimension
Inset to panels-connected at ends
- 2 STANDARD HEADER
2" x 4" nominal dimension
Inset to panels-connected at ends
- 3 RECYCLED GYPSUM
Interior finished with recycled gyp.
w/ recycled woods & paper from DeCon.
- 4 CONNECTOR JOINT
2x nominal dimension
/metal C-channel to inlay electrical
Sealant strip connection panels to joint
- 5 RECYCLED INSULATION
w/ recycled woods & paper from DeCon. /
Reused batt insulation
- 6 STANDARD DOOR FRAME
Framed w/2x nominal lumber
Cutout - 40" wide 82" tall
typ. door - 36" 80" tall
- 7 STANDARD WINDOW FRAME
Cutout - 26" wide 38" tall
typ. door - 24" wide 36" tall

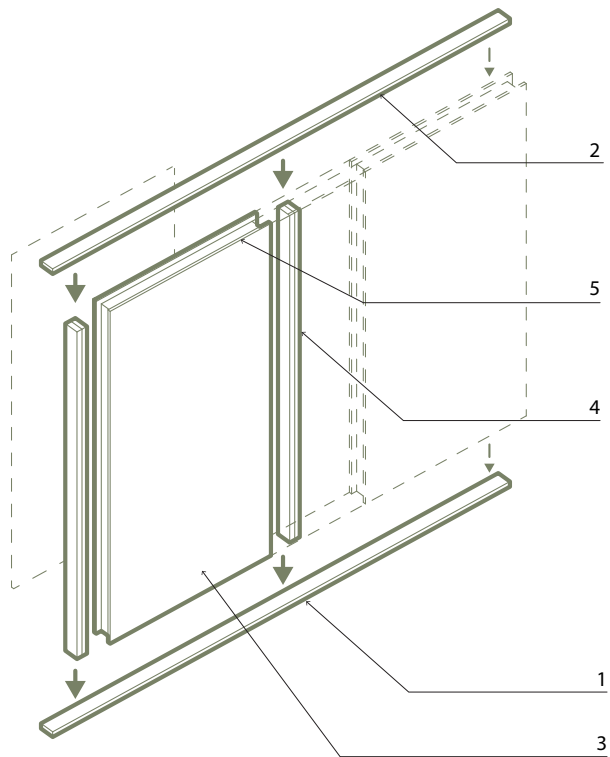

Standard Wall

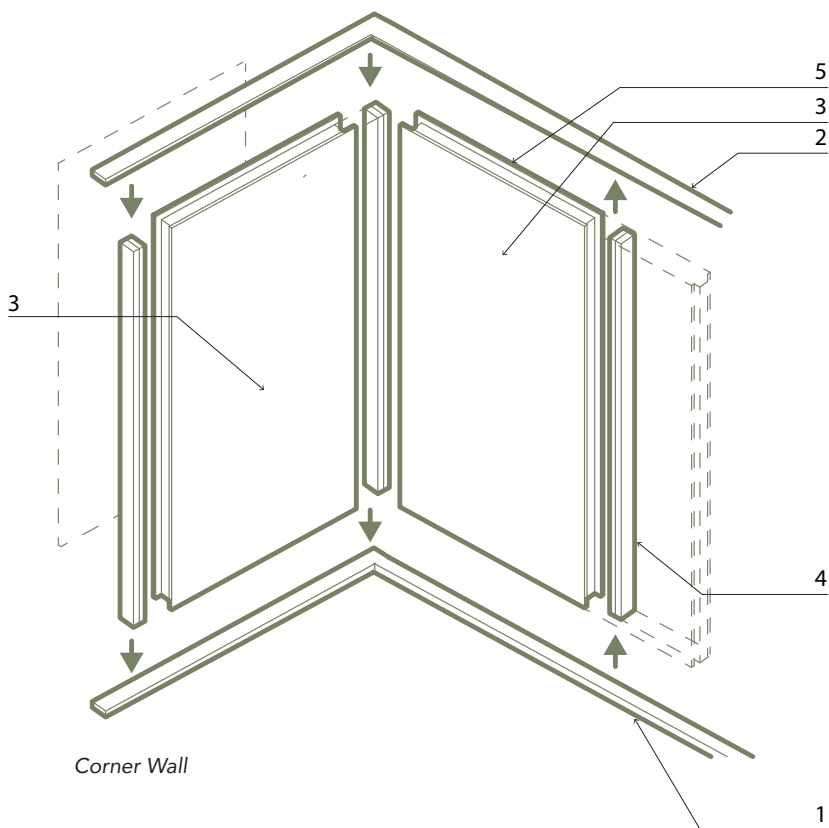

Corner Wall

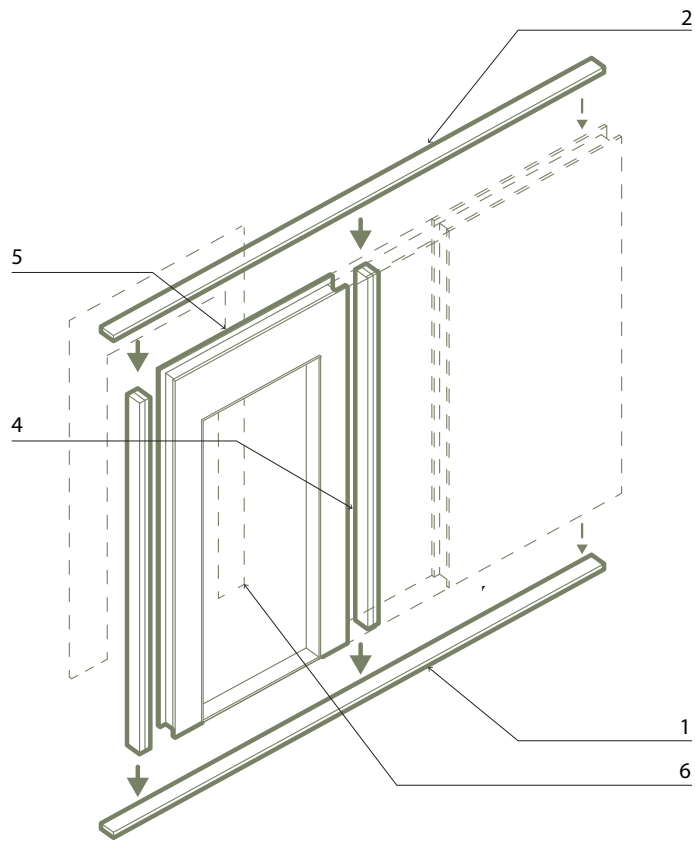

Door Opening

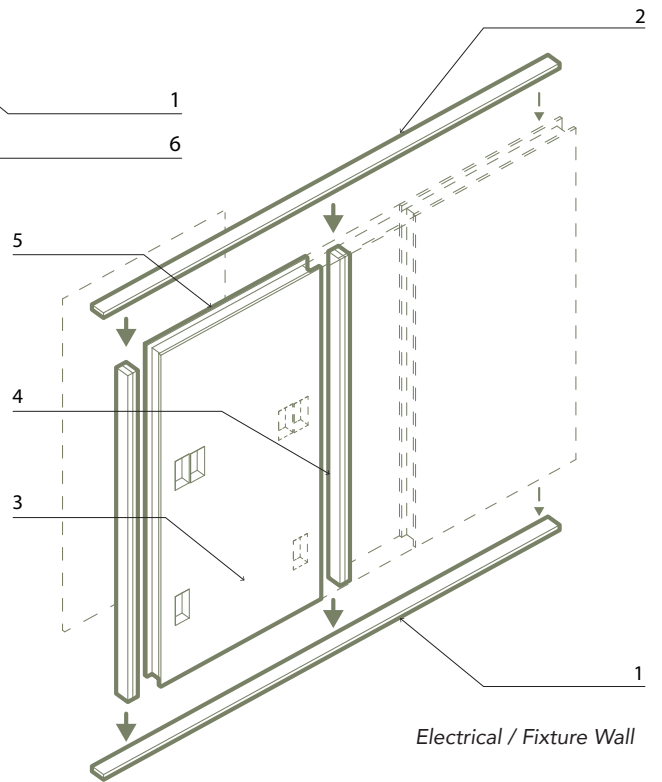

Electrical / Fixture Wall

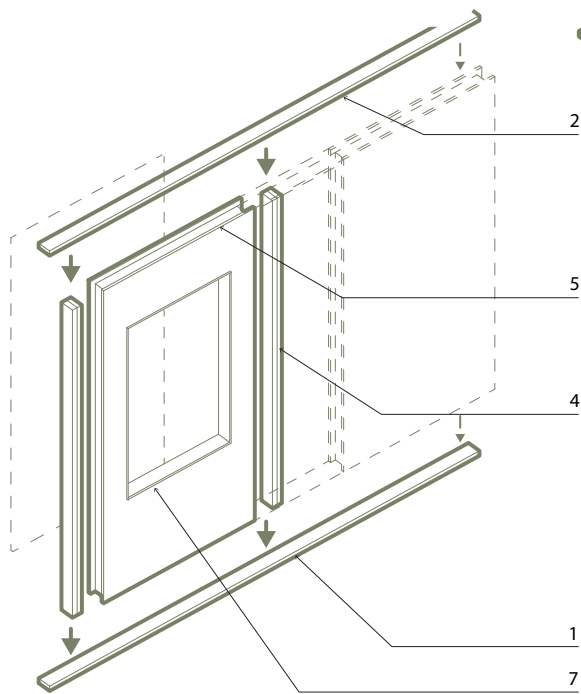

Window Opening

Axon Legend

- (A) INT. GYP BOARD
- (B) 3/4" OSB BOARD
- (C) 4"/6" RECYCLED INSUL.
- (D) 3/4" EXT. OSB BOARD
- (E) VAPOR BARRIER
- (F) PREASSEMBLED BRICK FACADE
- (G) PREASSEMBLED HARDIE BOARD
- (H) PREASSEMBLED BOARD & BATTEN
- (I) 2x WOOD DOOR FRAMING
- (J) 2x WOOD WINDOW FRAMING
- (K) 4" x 4" ELECTRICAL OUTLET CUT-IN
- (L) 4" x 4" LIGHTING SWITCH CUT-IN
- (M) 2" /4" DIAMETER PLUMBING CUT-IN
- (N) INSULATED CORNER CONNECTOR JOINT

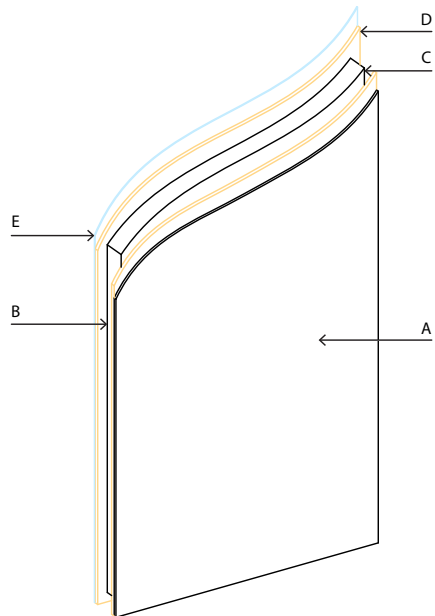
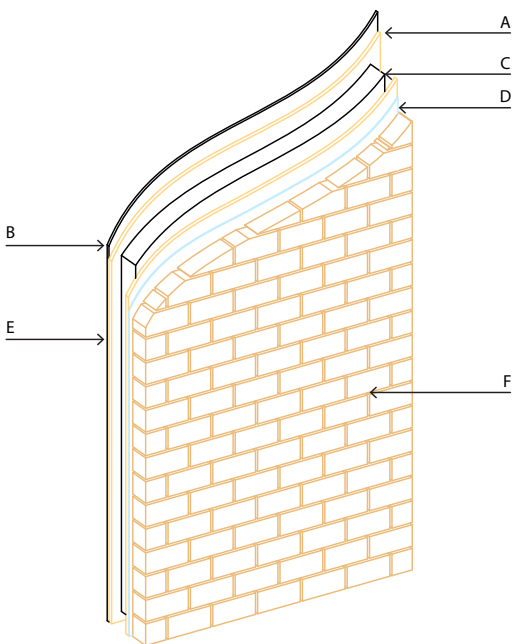
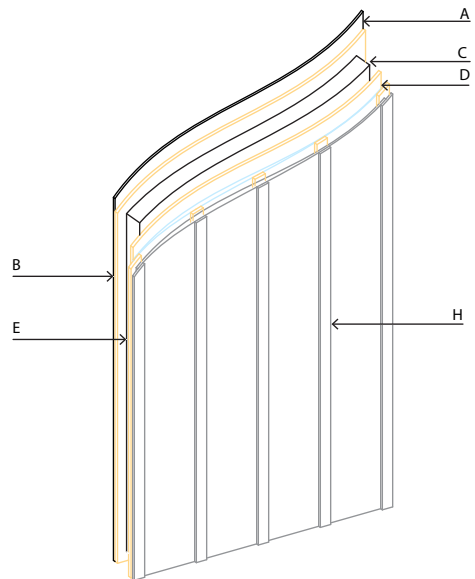
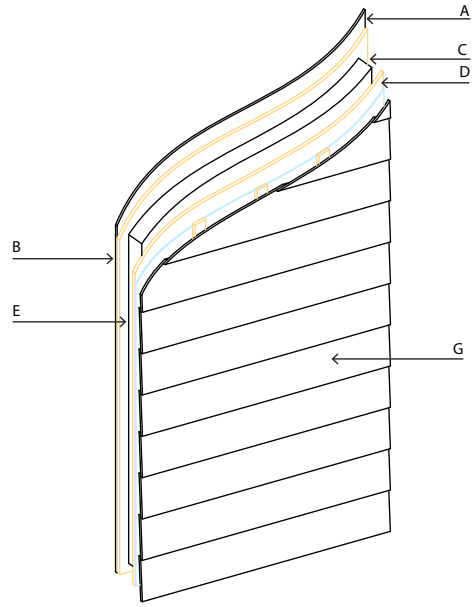

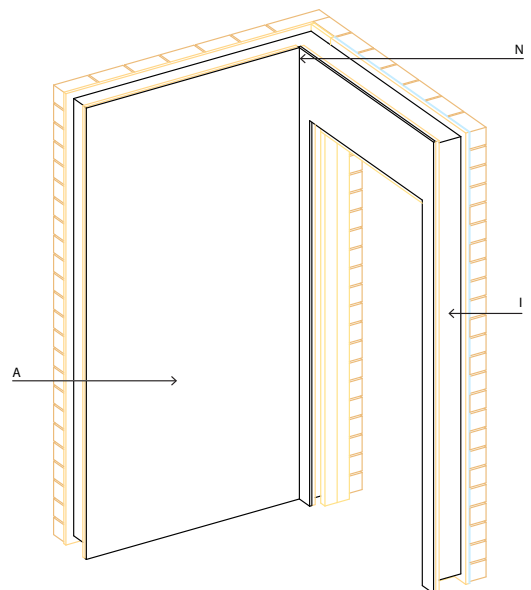
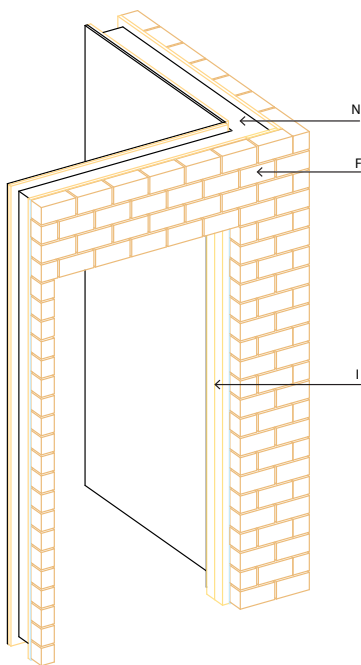
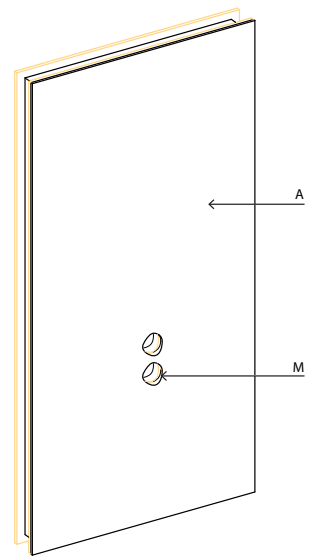
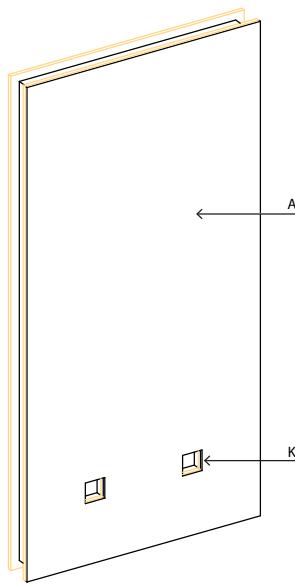
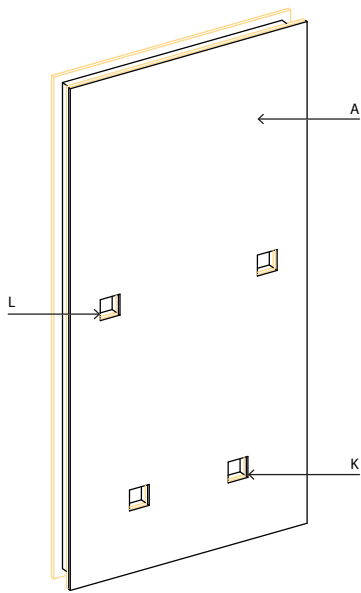
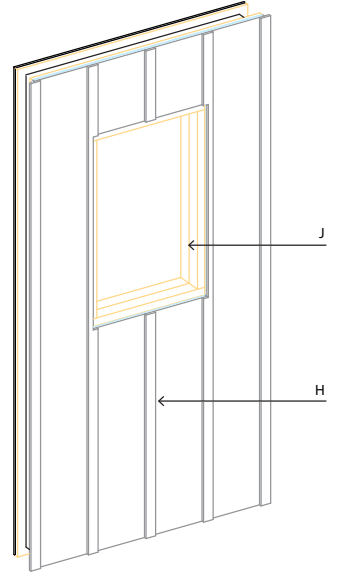
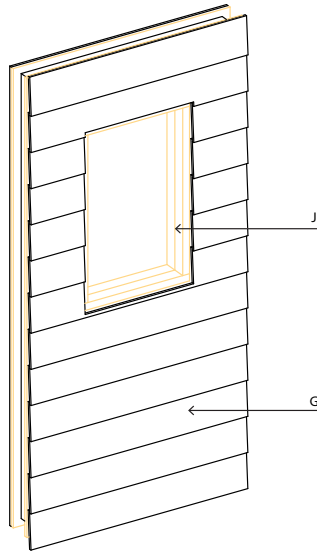
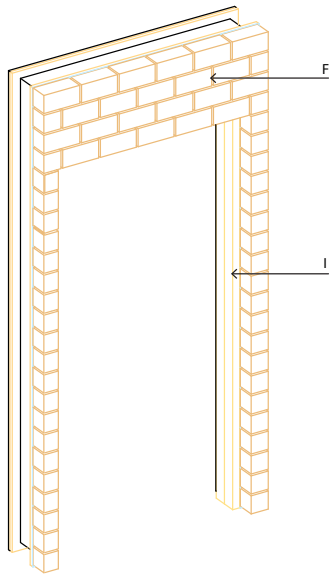

A SUSTAINABLE AND SAFE DESIGN

479 James P Brawley Dr

A home that is comfortable and safe for its occupants. The new renovated design uses the footprint of the existing house that is to be demolished to exempt the project from new zoning rules and also to maintain a the existing street scape. With the use of SIP systems for the layout maximizes natural daylight and cross ventilation in the house which maximizes its energy efficiency.

Durability

- Structural strength and stability
- Lifespan of 50 years or more

Affordability

- Long term value (5% more than on site)
- Reduced labor expenses
- Speedy construction

Sustainability

- Minimal waste and less waste to landfill
- Reduction in CO2 emissions

Energy Efficiency

- Save 25% in energy losses
- Lower energy bills
- Lower cooling energy demand

The renovation utilizes the plug-in 4x8' grid to house the SIPs units.

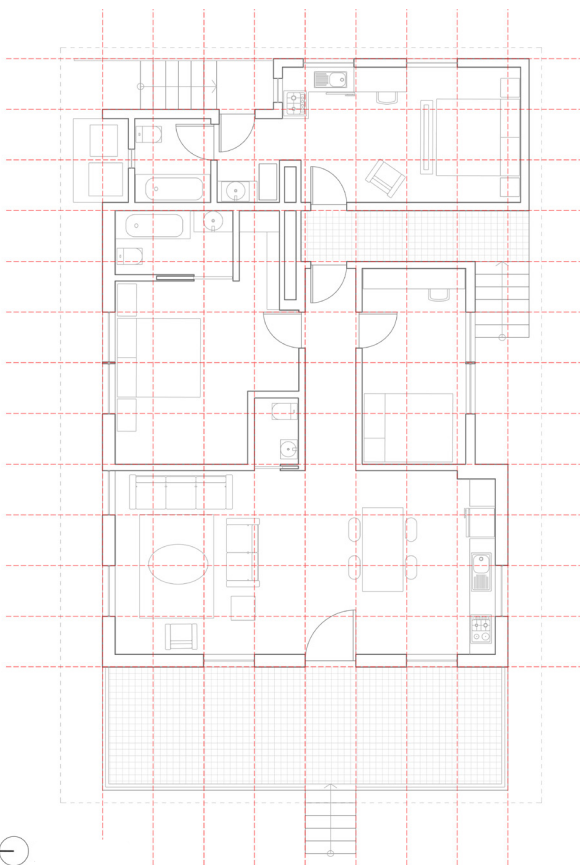

Proposed Plan Grid

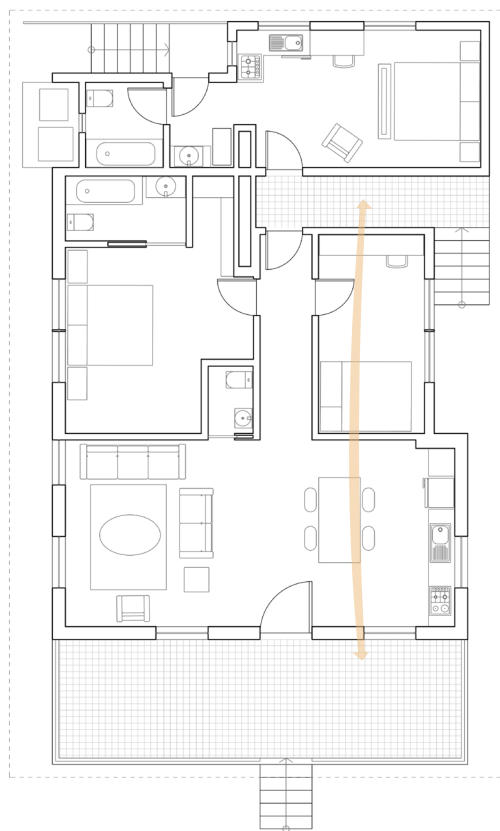

Proposed Plan

SIPS PANEL CRITERIA IN RELATION TO ENGLISH AVENUE

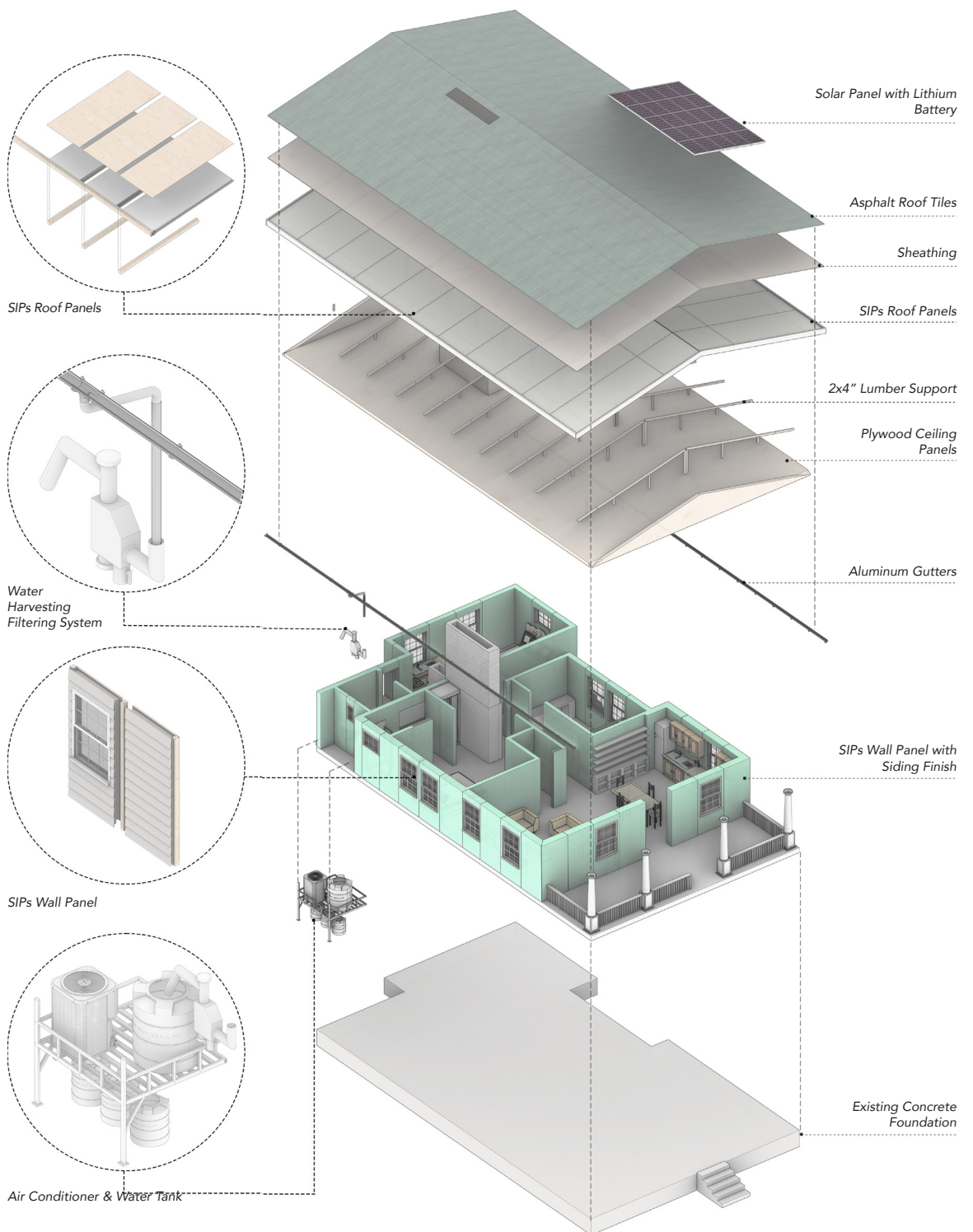

— A high-performing net-zero affordable home

— Minimum code

— This house/ Relatively high performing house

Affordability

cost/sft, revenue mechanisms

Neighborhood esthetics

Response to historic elements, material colours and finishes

Daylight

Visual comfort from daylight



Integrated systems

MEP systems, Daylight control, Renewables

Time

Site-built/manufacturing time, lifespan

Energy efficiency

EUI and oprational costs

ANALYSIS METRIC

In order to evaluate an affordable home's performance, it is essential to first specify the indicators of a high-performing affordable home. These definitions require a set of metrics and corresponding verification methods for each indicator to propose solutions for affordability and replication. It also allows comparison and influences the current building practices to improve the home's efficiency. This capability will strengthen builders, policymakers, home buyers, and other building industry stakeholders to participate in the shared agenda of efficient building design.

In order for it to be useful, the developed metric should be easily understood and employed by all stakeholders. Prioritizing this principle, we developed an **analysis metric** to analyze the preliminary designs developed by the students in response to history, architecture, and efficiency. Potential areas for improving performance were identified in the context of the neighborhood and degrees of prioritization were measured for each design.

The indicators evaluated are derived from insights gained during classroom discussions and stakeholder meetings as well as other literature on high-performing affordable homes:

AFFORDABILITY

The cost benchmark for the home is based on chosen construction technology and other efforts to maintain the affordability of homes.

INTEGRATED SYSTEMS

Does the design factor integrate plumbing, electrical, efficient HVAC, and water harvesting systems?

TIME

Time evaluates the chosen technology's processes to minimize construction time on-site and improve the speed of construction.

OPERATIONAL COSTS

This indicates the operational costs of the home like energy, water, and other utility bills paid monthly.

DAYLIGHT

Measurements of daylight within the homes

NEIGHBORHOOD ESTHETICS

This metric evaluates the design's response to contextual elements like the adoption of vernacular principles.

DESIGN ANALYSIS METRIC

Schematic Design 1, SIP Systems





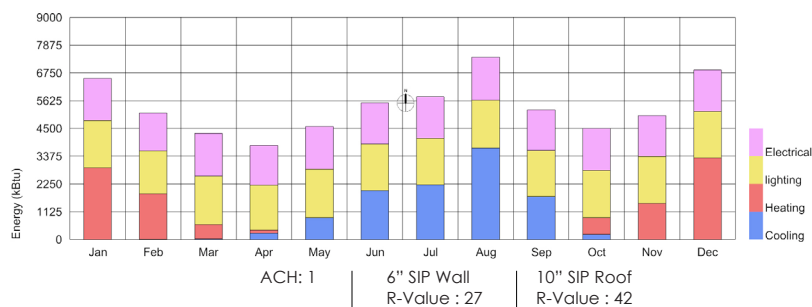
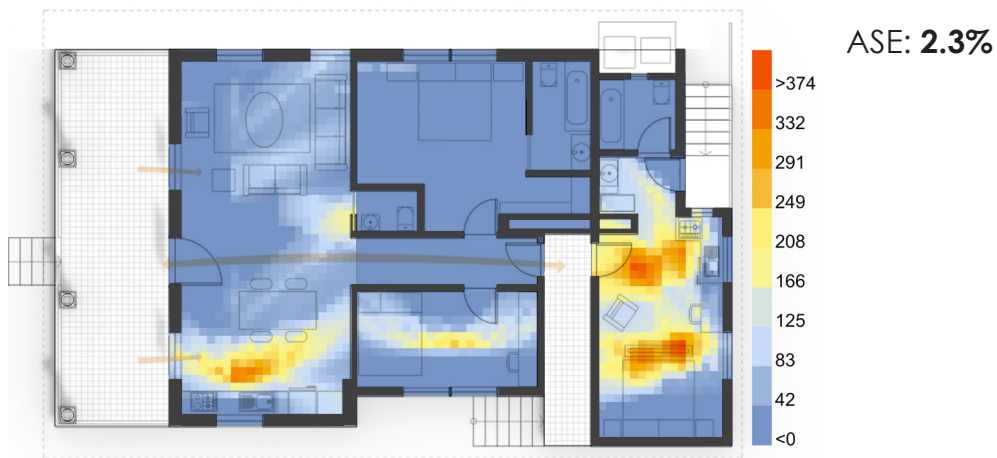
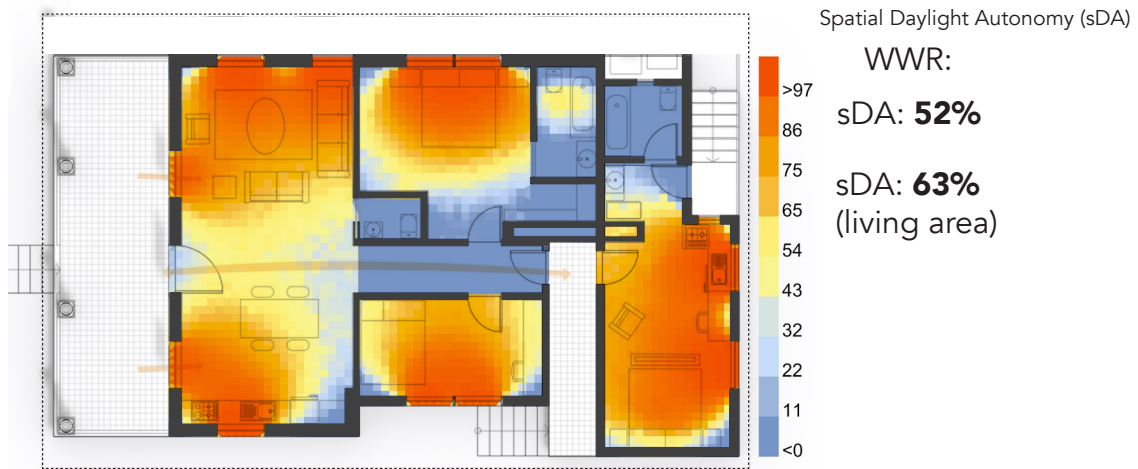



Spatial daylight autonomy (sDA) refers to the percentage of floor area where 30 fc (footcandles) is achieved for at least 50 percent of the workday. Higher sDA values indicates that a larger interior space receives at least 30 fc of daylight for at least 50 percent of the workday.

02.10 Continuing Education Center, Architecture + Construction



SIP systems are 15 times more airtight than traditional stick build construction making it not only energy efficient, but also durable for the same reason.

SIPs ensure interior and exterior airtightness in construction, making it one of the high-performing building materials.

	Design Case (SIP construction)				Base Case			
AFFORDABILITY	\$178,472	\$53,541	\$43,785	\$8,785	\$169,722	\$72,738		
	cost/sft (70% Total Cost) material cost	cost/sft (30% Total Cost) labor cost	construction cost +\$700 revenue/month 368 sf ADU unit	6kW Solar System Solar Kit	cost/sft (70% Total Cost) material cost	cost/sft (30% Total Cost) labor cost		
NEIGHBORHOOD ESTHETICS	240	2	\$5 - \$10		160	\$7 - \$9		
	front porch (sqft) covered living	number of stories building height	wood siding (sqft) exterior		porch (sqft) uncovered living	vinyl siding (sqft) exterior		
DAYLIGHT	63%	2.3%	19%		>55%	<30%		
	of 300 lux or more sDA	>100 fc for more than 250 hours ASE	WWR		of 300 lux or more recommended sDA	>100 fc for more than 250 hours ASE		
ENERGY EFFICIENCY	32.50 kBtu/sf		\$ 388		49 kBtu/sf	\$1,368.00		
	(without PV system) 16 kBtu/sf EUI with a 6kW PV system		- \$ 980 savings! Energy costs (per annum) with PV		Baseline stick build SFH without ADU	Energy cost (per annum)		
TIME	6w	1w	6w		6w	3w 9w		
	site and foundation construction time	framing and enclosure construction time	interior and finishes construction time		site and foundation construction time	framing and enclosure construction time	interior and finishes construction time	
SYSTEM INTEGRATION								
	72,175 gallons collection potential		6 kW system	Mini split with heat pump	Rainwater harvesting	Efficient fixtures, greywater recycling	PV Generation	HVAC

1,500 SF Wood Frame House

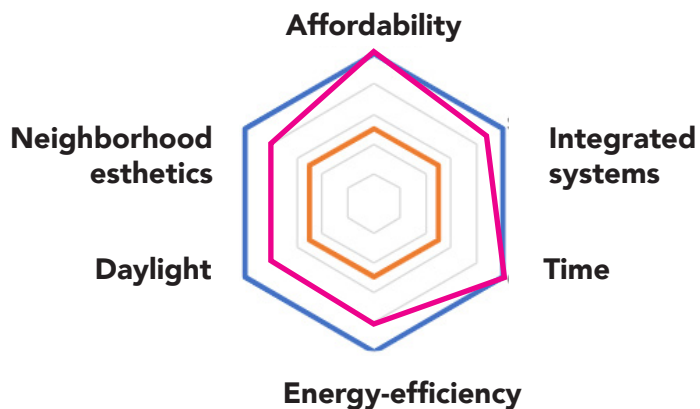

- A high-performing net-zero affordable home
- Minimum code
- This house/ Relatively high performing house



CROSS LAMINATED TIMBER

Structural System and Interior Finish

“Cross laminated timber (CLT) is a large scale, prefabricated, solid engineered wood panel. Lightweight yet very strong, with superior acoustic, fire, seismic and thermal performance, CLT is also fast and easy to install, generating almost no waste onsite. CLT offers design flexibility and low environmental impacts.

A CLT panel consists of several layers of kiln dried lumber boards stacked in alternating directions, bonded with structural adhesives, and pressed to form a solid, straight, rectangular panel. CLT panels consist of an odd number of layers (usually, three to seven,) and may be sanded or prefinished before shipping. While at the mill, CLT panels are cut to size, including door and window openings, with state of the art CNC (Computer Numerical Controlled) routers, capable of making complex cuts with high precision. Finished CLT panels are exceptionally stiff, strong and stable, handling load transfer on all sides.”

- Apawood

CLT offers an alternative to traditional stick-build wood construction. Both wall systems work to enclose the exterior of the structure and carry the weight of the roof, traditional wood-stud framing has to be assembled on site after the foundation is set. CLT, however, can be shipped to the site a complete wall assembly, reducing the construction time.

Benefits

- Reduced construction time
- Less interior finish materials
- Less waste on job site
- Higher fire rating
- Minimal embodied energy

The benefits of CLT are amplified when the scale of the project is increase but the following example shows CLT applied on a residential project.

NEW CONSTRUCTION CRITERIA

A Closer Look at English Avenue

	Relevance	CLT
Affordable	<p>Median Income for English Ave: \$32,948</p> <p>Median Income for Atlanta: \$66,657</p>	<p>CLT is 21% more Expensive than traditional build</p>
Sustainable	<p>Energy cost is an addition Expense not often included in the rent payment</p>	<p>Provides a durable airtight envelope and avoids thermal bridging</p>
Efficient	<p>Fast construction that allows minimal opportunities for theft</p>	<p>CLT + Pre-Cut system will allow for a construction speed 6x as fast as traditional construction</p>
Durable	<p>More renters than owners in the English Avenue community</p>	<p>Built for a lifetime 50+ years</p> <p>Require minimal maintenance</p>
Safe	<p>Create a beauty and safe environment</p>	<p>CLT panels can be produced with fire resistances of 30, 60, and 90 minutes</p>

CLT COST COMPARISON

CLT vs Light framed Wood
1,850 SF, 3 bed & 2 bath

Light framed wood build: \$393,085 **vs** CLT build \$476,545

21% more expensive
22 fewer days to complete

	Light Framed Wood	CLT	Combined
Project Preparation	\$153,300	\$153,780	\$153,780
Foundation	\$29,780	\$29,780	\$29,780
Frame Work	\$44,220	\$153,270	\$120,270
Exterior Work	\$31,295	\$31,295	\$31,295
Interior Work	\$42,930	\$44,860	\$44,860
Interior Work Final	\$50,560	\$51,360	\$51,360
Final Details	\$41,000	\$45,200	\$45,200
Total	\$393,085	\$509,545	\$476,545

Material

Around \$50 per square foot

\$14 per square foot less than a traditional concrete and steel building but higher than traditional stick built.

Labor

Smaller crews and faster construction time

Potentially cutting the cost of installation by 50% on average

CLT is more expensive in regards to initial cost but counters with an expedited shipping and construction time. Combining CLT with traditional wood framing offers the best return on material costs and construction time.

OPTIMIZED CLT DESIGN

491 Paines Ave NW



Speed

Materials are pre-fabricated & delivered on-site ready to assemble, dramatically reducing construction time & waste.



Custom

CLT panels are custom made per project. Therefore, they require more upfront design and a stronger collaboration with MEP.



Craftsmanship

CLT can be painted, plastered, or finish the exposed material.

03.04 EcoHouseMart

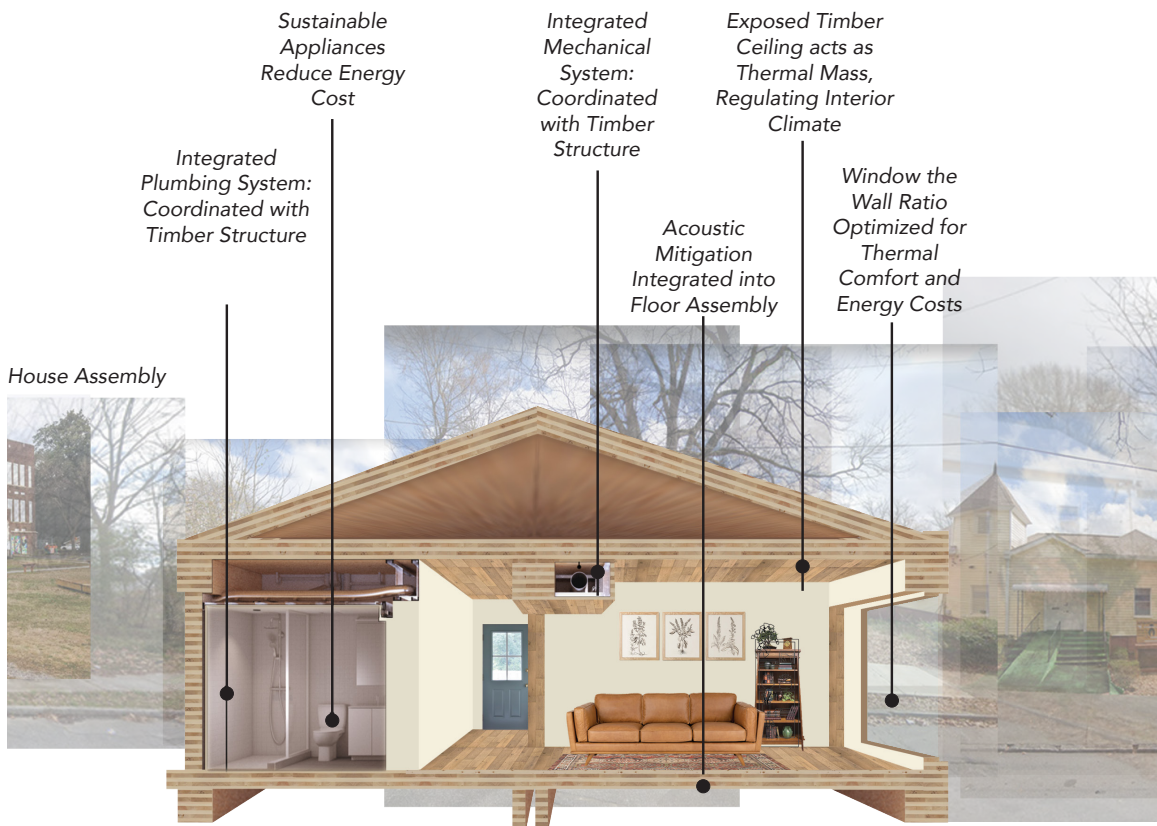

03.05 Minji Kim & Eden Wright, GaTech, 2022

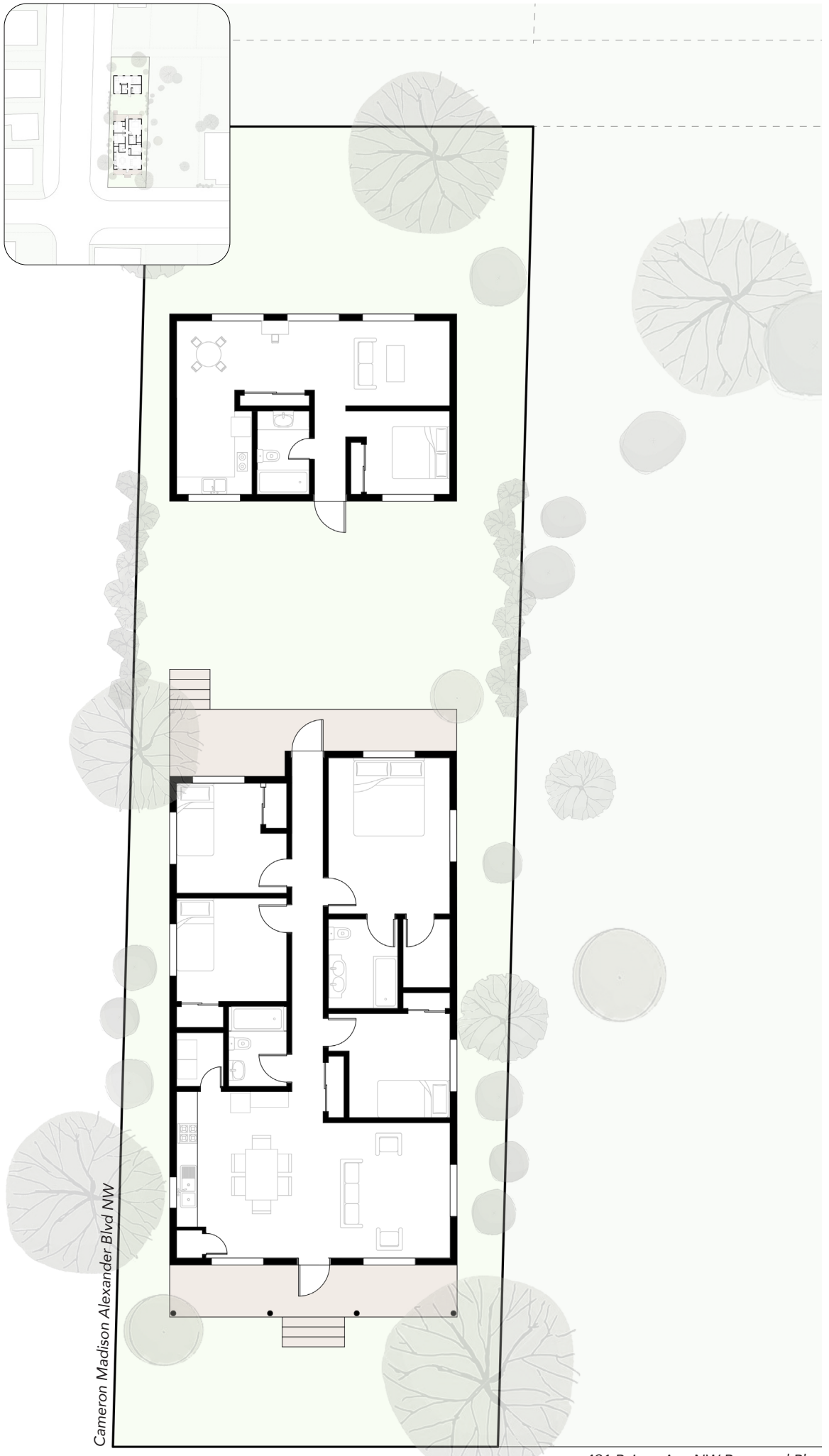

Cameron Madison Alexander Blvd NW

Paines Ave NW

491 Paines Ave NW Proposed Plan

WORKING WITH CLT

Construction System, Pre-Cut

“If we’re talking about modular houses, then we are talking about a pre-baked cake: you just buy it in the shop and maybe add frosting and decoration. Most of it is done when you buy it.

“If we are talking about element houses, then it’s like buying a dough mix: the mix is done you do the baking.”

“With pre-cut, you just get ingredients in the right proportions, and you are given a good recipe. This way, you don’t need so much in terms of skills.”

- katus.eu

What is pre-cut?

It is a type of prefabrication construction, commonly referred to as “Kit Homes”. Popular in the early 20th century because they provided quick, cheap, and efficient housing.

Kit Home – all parts are cut and prepared in a factory, therefore, ready to be constructed on site.

ASSEMBLY METHOD

Module CLT Units

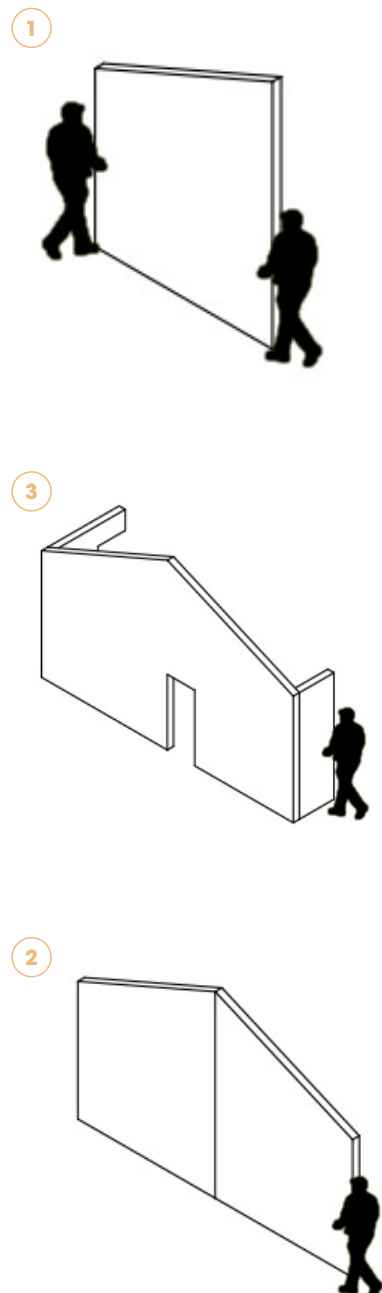

4

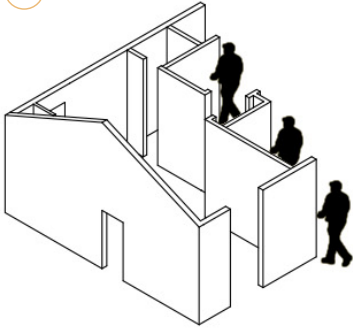

8

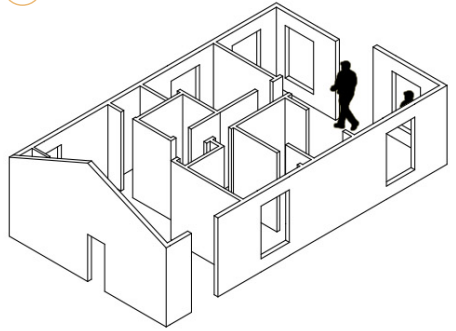

5

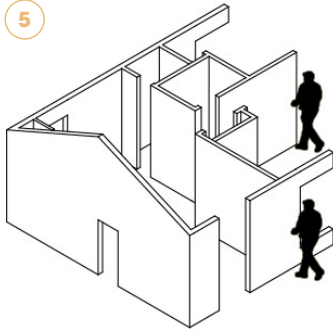

9

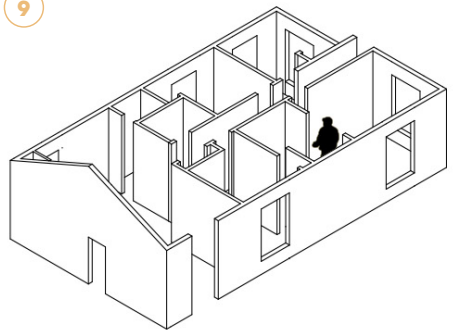

6

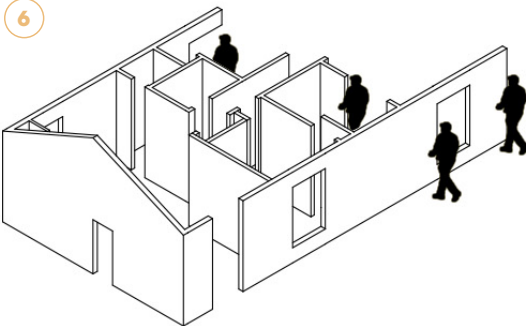

10

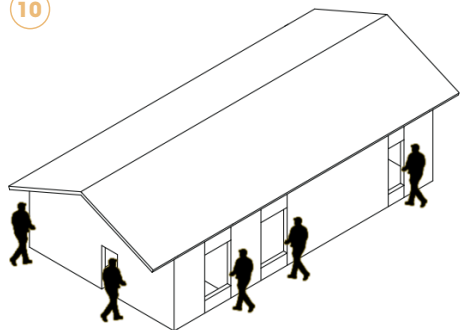

7

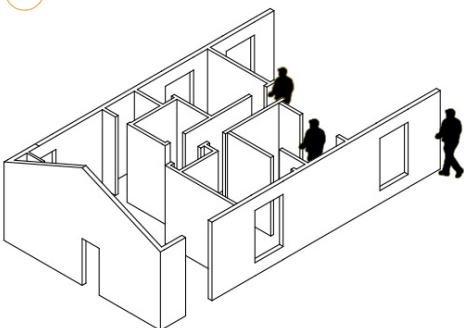

DESIGN ANALYSIS METRIC

Schematic Design 1, CLT System

Spatial daylight autonomy (sDA) refers to the percentage of floor area where 30 fc (footcandles) is achieved for at least 50 percent of the workday. Higher sDA values indicates that a larger interior space receives at least 30 fc of daylight for at least 50 percent of the workday.

03.07 Continuing Education Center, Architecture + Construction

Spatial Daylight Autonomy (sDA)

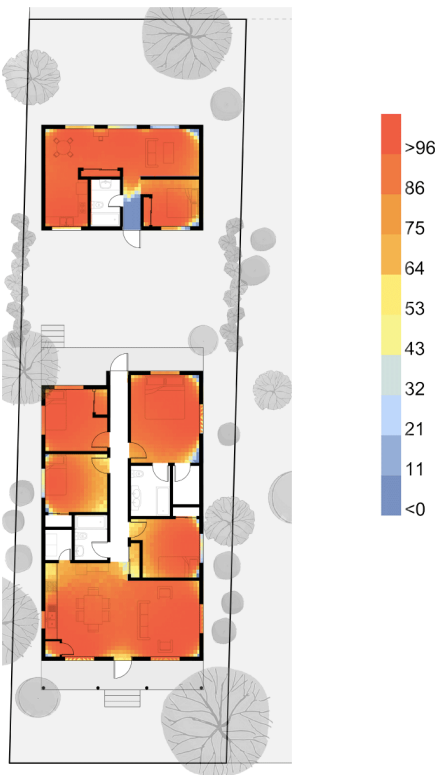



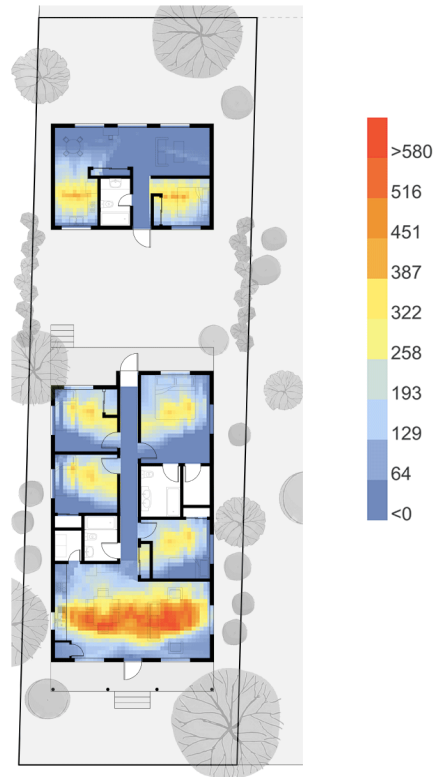



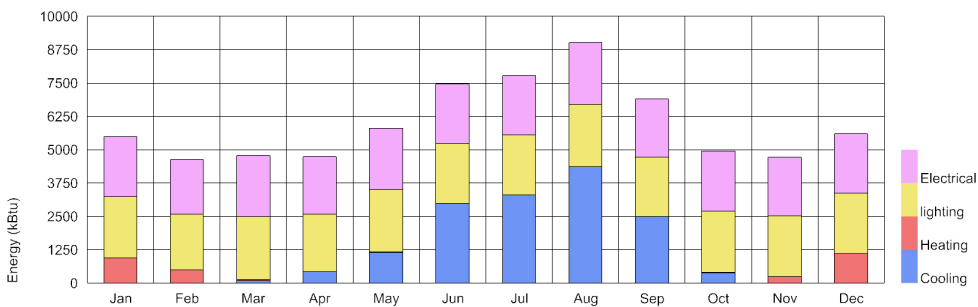

Annual Sunlight Exposure (ASE)



Energy Use Intensity : Monthly Chart (EUI)



	Design Case (CLT Construction)			Base Case (950 sq.ft)				
AFFORDABILITY	\$205,363	\$88,012	\$94,466	\$169,722	\$72,738			
	<small>cost/sft (70% Total Cost)</small>	<small>cost/sft (30% Total Cost)</small>	<small>construction cost +\$700 revenue/month</small>	<small>cost/sft (70% Total Cost)</small>	<small>cost/sft (30% Total Cost)</small>			
	material cost	labor cost	484 sf ADU unit	material cost	labor cost			
NEIGHBORHOOD ESTHETICS	130	1	-	160	\$7 - \$9			
	<small>front porch (sqft)</small>	<small>number of stories</small>	<small>wood siding (sqft)</small>	<small>porch (sqft)</small>	<small>vinyl siding (sqft)</small>			
	covered living	building height	exterior	uncovered living	exterior			
DAYLIGHT	81%	18.9%	18.9%	>75%	<30%			
	<small>of 300 lux or more</small>	<small>>100 fc for more than 250 hours</small>		<small>of 300 lux or more</small>	<small>>100 fc for more than 250 hours</small>			
	sDA	ASE	WWR	sDA	ASE			
ENERGY EFFICIENCY	27.86 kBtu/sf		\$ 630	49 kBtu/sf	\$1,368.00			
	<small>(without PV system)</small>			<small>Baseline stick build SFH without ADU</small>	<small>Energy cost (per annum)</small>			
	17 kBtu/sf		- \$ 738 savings!					
	<small>EUI with 4 kW PV</small>		<small>Energy costs (per annum) without PV</small>					
TIME	6w	4w	8w	6w	3w	9w		
	<small>site and foundation</small>	<small>framing and enclosure</small>	<small>interior and finishes</small>	<small>site and foundation</small>	<small>framing and enclosure</small>	<small>interior and finishes</small>		
	construction time	construction time	construction time	construction time	construction time	construction time		
SYSTEM INTEGRATION								
	<small>67,763 gallons collection potential</small>	<small>Water-efficient fixtures</small>	<small>4 kW system generation potential</small>	<small>Mini split with heat pump</small>	<small>code compliance</small>	<small>Rainwater harvesting</small>	<small>Efficient fixtures, greywater recycling</small>	<small>PV Generation</small>

AREAS OF ANALYSIS

1,500 SF Wood Frame House

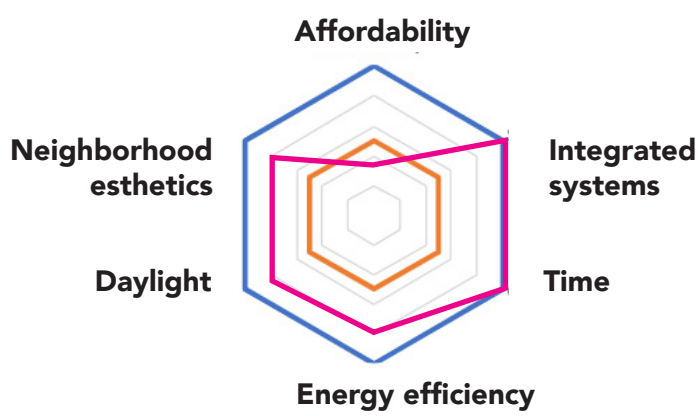

- A high-performing net-zero affordable home
- Minimum code
- This house/ Relatively high performing house



04.01 Moment Home / Momentum, Breanna Rhoden & Katie Reilly, 2021

KIT-OF-PARTS DESIGN

Personalized Design Options

This proposal seeks to establish a framework for living that can accommodate diverse family arrangements while simultaneously offering paths from tenant to home ownership. Building on the vernacular of the neighborhood and re-imagining the shotgun house, this project offers a nimble set of housing arrangements that can flexibly adapt to changing needs and demands.

From meetings with community stakeholders, our reading of the 2017 Land Use Framework Plan and neighborhood analysis we determined that our primary concerns would be addressing the high cost of homeownership and stitching together the successful patches of urban fabric in English Avenue.

There is an incredible opportunity to leverage the existing vacant lots to build a variety of residences and ADUs. This “kit-of-parts” design offers the owner modularized floor plans that best suit their family’s needs

Additionally, extending the existing historic Vernaculars (like the shotgun typology), that are inherently naturally daylighted and ventilated, cuts down on utility costs. Raised floor structures and the integration of bioswales and rain gardens into the landscape mitigate stormwater flooding. Food gardens and pollinator plants contribute to a balanced neighborhood ecosystem.

Finally, the shared exterior spaces and mix of family types in close quarters provide opportunities for neighbors to get to know each other, potentially provide for each other and build a more resilient, flourishing community.

MOMENT HOME \ MOMENTUM

A Path to Home Ownership

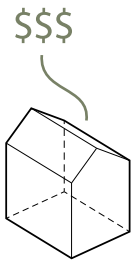

TYPICAL SINGLE FAMILY RESIDENCE HIGH COST: DOWN PAYMENT, MONTHLY MORTGAGE & INCREASING PROPERTY TAXES

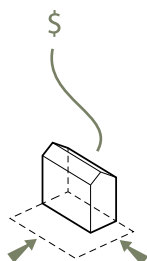

MINIMIZE SQUARE FOOTAGE LOWER DOWN PAYMENT

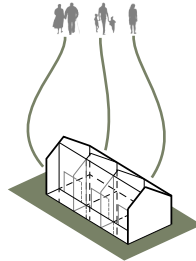

FLEXIBLE LAYOUTS PROVIDE FOR DIFFERENT FAMILY TYPES & ALLOW FOR CLASSIFICATIONS OF LESS BEDROOMS TO KEEP PROPERTY TAXES LOWER

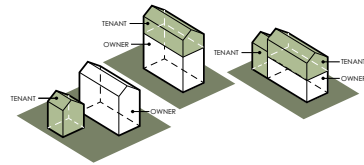

DIFFERENT TYPES OF HOME OWNERSHIP & ACCESSORY DWELLING UNIT CONFIGURATIONS: ATTACHED ADU'S, DETACHED ADU'S, ATTACHED GARAGES, DETACHED GARAGES, & SINGLE FAMILY HOMES ALLOW FOR PROGRESSION IN THE NEIGHBORHOOD & SHIFT HOME OWNERSHIP TO MINORITY LOCALS



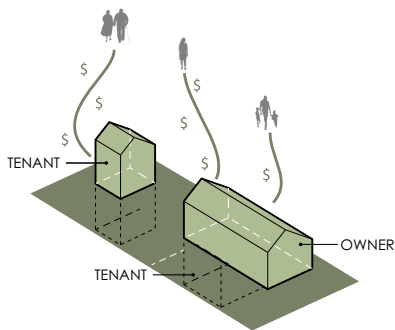

849 CAMERON MADISON ALEXANDER:
SINGLE FAMILY HOME + 1 DETACHED ADU
BASEMENT LEVEL ALLOWS FOR ADDITIONAL
SPACE TO BE A RENTAL UNIT & DETACHED
ADU CAN BE A RENTAL, GUEST COTTAGE
OR MOTHER IN LAW SUITE FOR HOMEOWNER

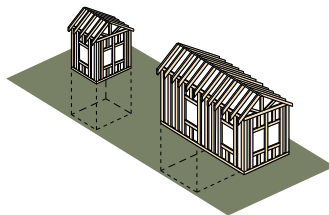

LIGHT WOOD FRAME
CONSTRUCTION ON A 4 FT GRID TO ALLOW
FOR SIMPLE ASSEMBLY DURING
CONSTRUCTION & FUTURE ADAPTATION
TO NEW MATERIALS

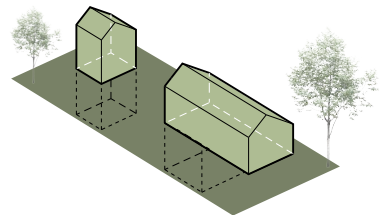

REPLANT POLLINATOR TREES AND
LOCAL PLANTS TO BRING BACK
THE NATURAL ECOSYSTEM





View from Street

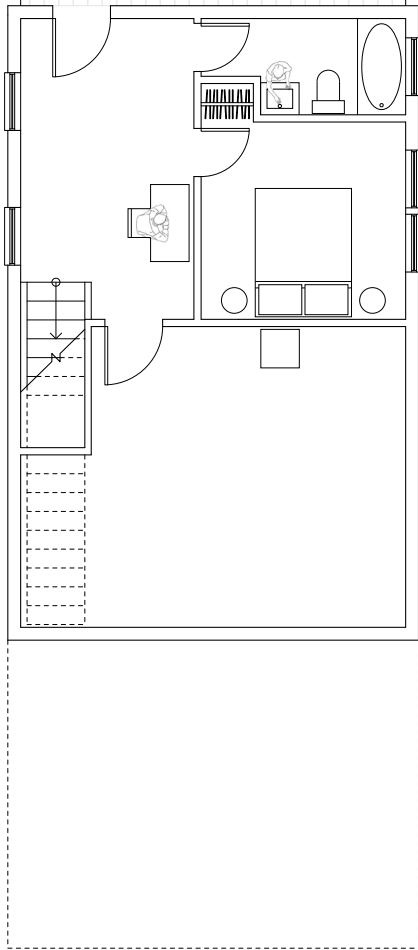
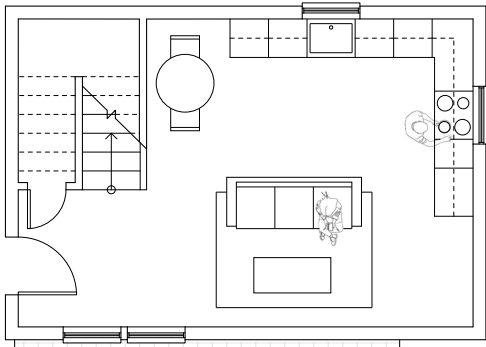

🕒 Basement Plan

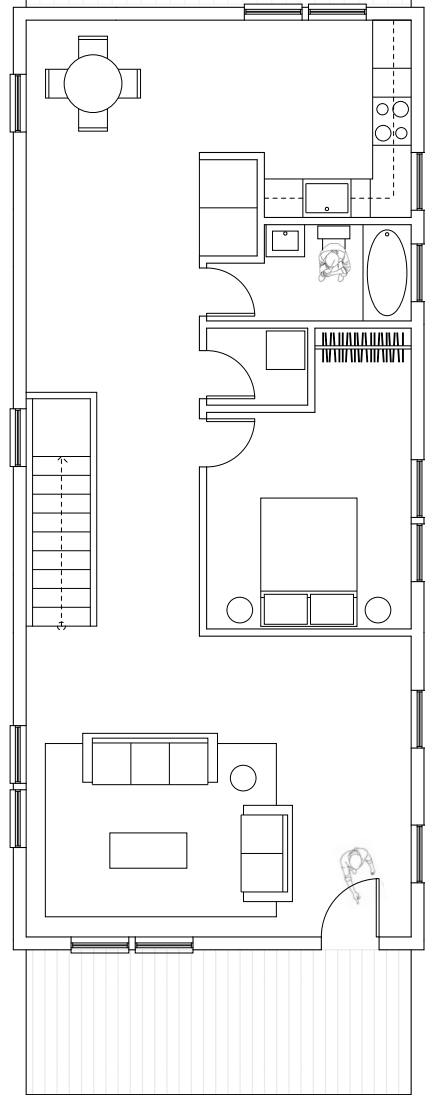
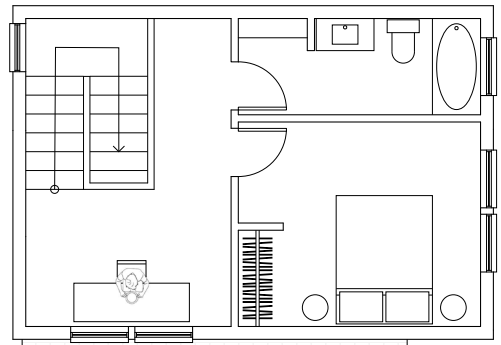

🕒 First Floor Plan

DESIGN ANALYSIS METRIC

Schematic Design 1, Kit-of-Parts System







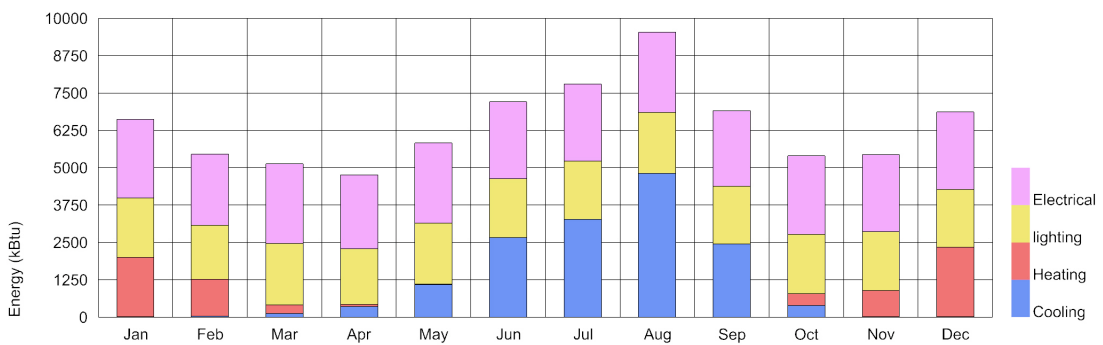
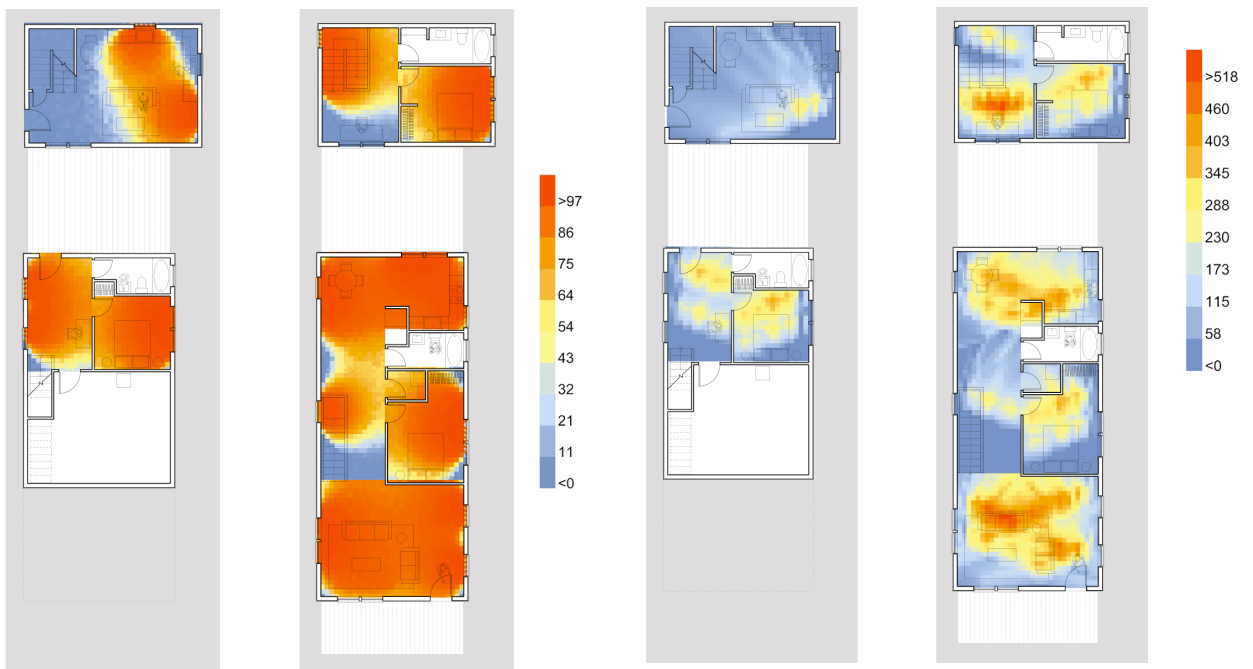

Spatial daylight autonomy (sDA) refers to the percentage of floor area where 30 fc (footcandles) is achieved for at least 50 percent of the workday. Higher sDA values indicates that a larger interior space receives at least 30 fc of daylight for at least 50 percent of the workday.

04.03 Continuing Education Center, Architecture + Construction

Spatial Daylight Autonomy (sDA)

Annual Sunlight Exposure (ASE)



	Design Case (Kit-of-Parts)			Base Case				
AFFORDABILITY	\$123,897	\$53,085	\$109,728 <i>construction cost</i>	\$169,722	\$72,738			
	<i>cost/sft (70% Total Cost)</i>	<i>cost/sft (30% Total Cost)</i>	+\$700 <i>revenue/month</i>	<i>cost/sft (70% Total Cost)</i>	<i>cost/sft (30% Total Cost)</i>			
	material cost	labor cost	930 sf ADU unit	material cost	labor cost			
NEIGHBORHOOD ESTHETICS	240	2	\$5 - \$10	160	\$7 - \$9			
	<i>front porch (sqft)</i>	<i>number of stories</i>	<i>wood siding (sqft)</i>	<i>porch (sqft)</i>	<i>vinyl siding (sqft)</i>			
	covered living	building height	exterior	uncovered living	exterior			
DAYLIGHT	70.5%	16.2%	18%	>75%	<30%			
	<i>of 300 lux or more</i>	<i>>100 fc for more than 250 hours</i>		<i>of 300 lux or more</i>	<i>>100 fc for more than 250 hours</i>			
	sDA	ASE	WWR	sDA	ASE			
ENERGY EFFICIENCY	37.01 kBtu/sf <i>(without PV system)</i>		\$ 898	52.97 kBtu/sf	\$1,368			
	27.5 kBtu/sf <i>EUI with 3.5 kW PV</i>		- \$ 470 savings! <i>Energy costs (per annum) without PV</i>	<i>Baseline stick build SFH without ADU</i>	<i>Energy cost (per annum)</i>			
TIME	6w	1w	6w	6w	3w 9w			
	<i>site and foundation</i>	<i>framing and enclosure</i>	<i>interior and finishes</i>	<i>site and foundation</i>	<i>framing and enclosure</i>	<i>interior and finishes</i>		
	construction time	construction time	construction time	construction time	construction time construction time			
SYSTEM INTEGRATION								
	<i>72,175 gallons collection potential</i>			<i>Mini split with heat pump</i>	<i>code compliance</i>	<i>Efficient fixtures, greywater recycling</i>	<i>PV Generation</i>	<i>HVAC</i>

1,500 SF Wood Frame House

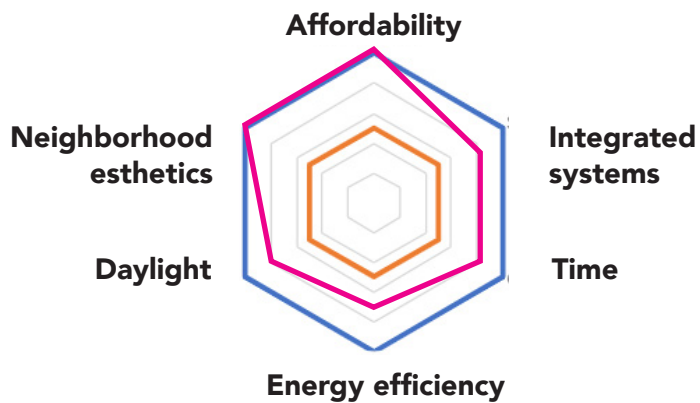

- A high-performing net-zero affordable home
- Minimum code
- This house/ Relatively high performing house

CONCLUDING THOUGHTS

The problems facing the English Avenue Neighborhood are not isolated conditions but rather showcase a network of problems facing low-income communities around large US cities. Increasing the urgency of a design prototype to provide for undeserved communities. As the students studied the current site conditions, precedents for innovation fabrication and affordable housing, and design prototypes, they began to understand the impact equitable design can have on the homeowner and neighborhood fabric.

Reflection on the initial design considerations:

1) Issues on community and identity

The students conducted a thorough analysis of the current site conditions for the three residential lots selected for the prototype development. Along with visiting the site and documenting the existing structures, they participated in community meetings to gain insight into the unspoken issues of community and identity. The question was raised – why has it taken so many years to purchase and renovate properties in the area? After a candid conversation with a leading member of the community, the class began to see beyond the physical fabric of the neighborhood to identify larger fears and concerns of the residents. The longer-term, generational residents spoke of the concerns they have about

renovation properties near their own. Would that raise the property taxes on their lots, effectively increasing their monthly expenses? These concerns are realistic as many East side Atlanta neighborhoods are recovering from the massive effects of gentrification from development in the last ten years.

By empathizing with current residents and being eager to understand the desires of the community, the students documented the visual characteristics of the neighborhood. Documenting the architectural characteristics of the properties is an important step in recognizing the value of the existing neighborhood. The students carried these elements forward in their research.

2) advancements in technology and production, including evaluating opportunities for innovative fabrication/ assembly initiatives and reuse-repurposing finite resources

All three properties of the study are constructed using traditional wood framing. With the years of weather damage and improper maintenance by the property owner, the houses need new building construction beyond a simple renovation. The students studied various types of building precedents including affordable housing models, salvaged site materials, and prefabricated modular units. Together with the knowledge of the needs of the community, they designed three types of single-family home design.

3) energy performance, resiliency, and sustainability.

The three design proposals offer smart solutions to the needs of English Avenue. Unique in each of their approaches, they provide a property that is sustainable and energy-efficient for the long-term use of the resident. Each proposal preserves a similar size and scale to the existing projects and employs smart strategies, learned from the study of precedent projects.

Moving forward:

As a 'proof of concept', the FC2 team will employ a combination of the three strategies above in the development of new construction on Jett St NW. This will provide a beautiful space for a resident of English Avenue and test the new sustainable, affordable design.

CREDITS

copy

CONTENT REFERENCES

MISSION

DESIGN FOR ENGLISH AVENUE

- 01.01 *English Avenue 1912, Digital Library of Georgia*
- 01.02 *Atlanta Preservation Center*
- 01.03 *Context Plan, English Avenue Neighborhood*
- 01.04 *Atlanta's Past Revisted*
- 01.05 *Site Photos, English Avenue Neighborhood, GaTech*
- 01.06 *Atlanta Preservation Center*
- 01.07 *FC2 Project Proposal*
- 02.01 *SIP m3 House, Ian Hsu + Gabriel Rudolphy, 2014*
- 02.02 *Build With Rise*
- 02.03 *ZS2 Technologies*
- 02.04 *IP System Building Examples*
- 02.05 *stocorp.com*
- 02.06 *Weston Bylery & Luke Davis, GaTech, 2022*
- 02.07 *Weston Bylery & Luke Davis, GaTech, 2022*
- 02.08 *Keyhan Khaki & Milamem Lauriane Donang, GaTech, 2022*
- 02.09 *Metrics for high performance affordable housing, programs.fas.org*
- 02.10 *Continuing Education Center, Architecture + Construction*
- 02.11 *sips.org/publications*
- 03.01 *Smartware CLT Office Building, Vertical Studio, 2020*
- 03.02 *Cross Laminated Timber (CLT) APA The Engineered Wood Association (apawood.org)*
- 03.03 *CLTArchitecture.com*
- 03.05 *Minji Kim & Eden Wright, GaTech, 2022*
- 03.06 *katus.eu*
- 03.07 *Continuing Education Center, Architecture + Construction*
- 03.08 *sips.org/publications*
- 04.01 *Moment Home / Momentum, Breanna Rhoden & Katie Reilly, 2021*
- 04.02 *Breanna Rhoden & Katie Reilly, GaTech 2021*
- 04.03 *Continuing Education Center, Architecture + Construction*
- 04.04 *sips.org/publications*

ANALYSIS

SITE STUDY

1. Resources

CASE STUDY

CURRENT PROJECTS

- 01.01 Hawthorn Solar Extension, Sherbrooke Design and Construction, 2017
- 01.02 Neighborworks Rural Initiative
- 01.03 Neighborworks Rural Initiative
- 01.04 Neighborworks Rural Initiative
- 01.05 archdaily.com
- 01.06 Jennifer Bonner, Architect
- 01.07 City Forster, Architecture + Urbanism
- 01.08 Architekturbüro K & F ZT, Architecture
- 01.09 City Forster, Architecture + Urbanism
- 01.10 EchoUseMart, fire timber works
- 01.11 EchoUseMart, fire timber works
- 01.12 City Forster, Architecture + Urbanism
- 01.13 Sips.org
- 01.14 Treehugger, Blogger
- 01.15 Ecocor Shelter Evolved
- 01.16 Richard Pedranti Architecture
- 01.17 Kaplan Thompson Architects
- 01.18 Turning Leaf Custom Homes
- 02.01 The Architecture of Salvage, 2022
- 02.02 International Association of Certified Home Inspectors
- 02.03 Nick Gromicko, CMI, 2022
- 02.04 Nick Gromicko, CMI, 2022
- 02.05 LifeCycle Building Center
- 02.06 MATCH Program
- 03.01 Litibu Bungalow, Palma - 2020
- 03.02 Neighborhood Housing Services
- 03.03 Elements of Affordable Housing
- 03.04 Elements of Community
- 03.05 What is a Healthy Community, The Lincy Institute, 2012
- 03.06 Niche, School and Community Data
- 03.07 Homeownership Rate by Income
- 03.08 Land Use Framework Plan
- 03.09 Westside Future Funds, pg 81
- 03.10 Westside Future Funds
- 03.11 Site Photos
- 03.12 Breanna Rhoden and Katie Reilly, GaTech, 2021
- 03.13 Front Perspective, MicroLife Institute
- 03.14 Front Perspective, Rural Studio
- 03.15 Front Entrance, Rural Studio
- 03.16 Elevation, Palma
- 03.17 Front Elevation, Abendroth Architekten
- 03.18 Front Perspective, Hus Arquitetos
- 03.19 Front Perspective, Fabrica De Casas
- 03.20 Front Perspective, Alejandro Soddia
- 04.01 Kaplan Thompson Architects
- 04.02 Energy.gov
- 04.03 Dan Rockhill
- 04.04 aiatopten.org
- 04.05 Jim Vlock First Year Building Project / Yale School of Architecture
- 04.06 endeavourcentre

