

# P&IDs and Symbols

A Primer for Students who have not taken EMEC125

EMEC130



This program is funded in part/in whole by the U.S. Department of Labor - Employment and Training Administration. This work is licensed under a Creative Commons Attribution 4.0 Unported License.

## P&ID – Widely Understood?



- P&ID is an acronym that is well understood to be the document used to define a process.
- Definition:
  - “A schematic diagram of the relationship between instruments, controllers, piping, and system equipment.” (Kirk, Weedon, & Kirk, 2014, p. 23)
- P&IDs are a symbol based schematic language that once understood, adds simplicity to the information being presented.
- They can also be confusing when a unique symbol appears.
- There is no real standard for what should be included on the drawing.

P&IDs are the documents that technicians will use when troubleshooting and/or repairing instrumentation.

The symbols must be understood and are defined by the ANSI/ISA-5.1-2009 Standard; however, there is no real standard that specifies how much information and what type of information should be on these drawings. This can cause confusion when a technician is trying to decipher the meaning of a unique symbol that the designer included. As a designer, if a unique symbol is to be used there should be a note and/or a key on the drawing stating what the symbol represents and its function.

## P&ID Acronym



- What does P&ID stand for?
- The letter meanings are not universal.
- ‘P’ could stand for “Piping” or it could stand for “Process”.
- ‘I’ could represent “Instrumentation” or represent “Instrument”.
- ‘D’ could mean “Drawing” or it could mean “Diagram”.
- Which ever is used, including those not listed, we are all talking about the same document(s).

Discuss the different meanings of the letters in P&ID.

## New ISA Standard – ISA-5.7 (*Not Yet Released*)

- As mentioned, “there is no universal, national, international or international multi-discipline standard that covers the development and content of P&IDs” (Meier & Meier, 2011, p. 27)
- The ISA is in the process of creating a standard that will be known as: ISA-5.7 and is based on the Process Industries Practice (PIP) PIC 001.
- There is a standard that governs the symbols used on P&IDs. This standard is ANSI/ISA-5.1-2009 Instrument Symbols and Identifications. (See the introduction to this course)

A discussion should be held about how not all P&IDs use common symbols from company to company and even within the same company.

Discuss how, as drawings are updated over the years by various people, different symbols can be used for the same thing on different drawings within a drawing package.

Also introduce the concept of loop numbering and loop numbering schemes. Do not talk about these schemes in detail, that will come later; however, mention that the ISA-5.1 lists nine different loop numbering schemes and some of them “are parallel - a duplicated numerical sequence for each loop variable. Others schemes are serial, a single numbering sequence for all loop variables.” (Meier & Meier, 2011, p. 29).

There will be much more about symbols and loop numbering later in this chapter.

## What Comes From P&IDs?

- Instrument Lists or Index
  - Documents specifications, acquisition and installation
- Motor Lists
  - Size, horsepower, voltage
- Piping
  - Line lists, sizes, service and purpose
- Tanks & Vessels
  - Information about tanks and vessels
- All this information is used to lay out equipment, start specifying and purchasing the necessary equipment.

Discuss what information is taken from P&IDs and how it can be used.

If an actual P&ID drawing is available, show parts of the drawing that identify some or all of the items listed on this slide.

## Control Loop

- A collection of equipment consisting of at least three devices used to automatically control a process or a part of a process
- The three most common devices is:
  - A transmitter used to sense the PV and transmit the measured value to a controller
  - A controller used to compare the PV with a setpoint and generate a signal based on that comparison
  - A final control element that corrects the process

Discuss the basics of a control loop. Mentions some of the more standard signals such as:

- 4-20mA
- 3-15 psig (pounds per square inch gauge)
- 6-30 psig
- 1-5VDC
- 10-50mA
- 0-10VDC
- -10 to 10VDC

The next slide contains a simple control loop

## ANSI/ISA-5.1

- As stated earlier, the ANSI/ISA-5.1 is most often used by designers as the standard for symbology. Following is a direct quote from the standard:

“The symbols and identification methods contained in this standard have evolved by the consensus method and are intended for wide application throughout all industries. The symbols and designations are used as conceptualizing aids, as design tools, as teaching devices, and as a concise and specific means of communication in all types and kinds of technical, engineering, procurement, construction, and maintenance documents and not just in Piping and Instrumentation Diagrams.” (International Society of Automation, 2009)

Discuss the standard and why it is important to follow the standard whenever possible.

## Identification Letters

- The ANSI/ISA-5.1-2009 Instrumentation Symbols and Identification standard lists the preferred First Letter and Succeeding Letters.
- The standard also lists typical letter combinations.
- Keep these lists handy when reading or creating P&ID's.

Click the hyperlink to display a PDF for the ANSI/ISA-5.1-2009 Standard list of Identification Letters.

The Standard Identification Letters are on Page 30 of the standard, with notes about the table in Section 4.2 on Page 25 to 29.

The Allowable Succeeding Letter Combinations are on Page 106 to 108 of the standard

Discuss some examples such as those on page 42 in the textbook.



# ISA Identification Letters

**Table 4.1 — Identification letters**

Note: Numbers in parentheses refer to the preceding explanatory notes in Clause 4.2.

	First letters (1)		Succeeding letters (15)		
	Column 1	Column 2	Column 3	Column 4	Column 5
	Measured/Initiating Variable	Variable Modifier (10)	Readout/Passive Function	Output/Active Function	Function Modifier
<b>A</b>	Analysis (2)(3)(4)		Alarm		
<b>B</b>	Burner, Combustion (2)		User's Choice (5)	User's Choice (5)	User's Choice (5)
<b>C</b>	User's Choice (3a)(5)			Control (23a)(23e)	Close (27b)
<b>D</b>	User's Choice (3a)(5)	Difference, Differential, (11a)(12a)			Deviation (28)
<b>E</b>	Voltage (2)		Sensor, Primary Element		
<b>F</b>	Flow, Flow Rate (2)	Ratio (12b)			
<b>G</b>	User's Choice		Glass, Gauge, Viewing Device (16)		
<b>H</b>	Hand (2)				High (27a)( 28a)(29)
<b>I</b>	Current (2)		Indicate (17)		

## Instrument Identification (Tag Numbers)

- All instruments should have a metal, plastic or paper tag attached to them that states an instrument identification number; known as a “Tag Number”.
- There are several numbering schemes; however, the ISA standard, ISA-RP-5.1 (1949) superseded by ANSI/ISA-5.1-1984 (R 1992) superseded by ANSI/ISA-5.1-2009 is the most common.
- Tag numbers are an alpha-numeric code where the:
  - Alpha portion should be no more than four upper case characters
  - Numeric portion should be know more than four digits.
- The smaller the tag number, the better.

## Typical Instrument Tag Number

- PDT 102 – Instrument Identification or Tag Number
  - PDT – Function Identification
  - P 102 – Loop Identification
  - 102 – Loop Number
  - P - First Letter
  - DT - Succeeding Letters
- The most common identifiers are used for the most common process variables in process control:
  - F – Flow
  - L – Level
  - P – Pressure
  - T - Temperature

Note: Hyphens are optional as separators

Discuss the use of Letters and numbers and some generic variations. Then proceed to the next slide where there will be a link to the Identification Letters from the ANSI/ISA-5.1 Standard.

PDT represents a Pressure Differential Transmitter

## The Letter 'X' as a First Letter

- The letter 'X' as a first letter in a special case.
- The ANSI/ISA-5.1-2009 Standard states:
  - "First-Letter or Succeeding-Letter for unclassified devices or functions (X), for non-repetitive meanings that shall be defined outside tagging bubbles or by a note in the document." (International Society of Automation, 2009)
- A legend sheet and descriptive letters next to the bubble should define the function letter 'X'.
- Proper use is to not use the letter 'X' frequently and when used should only be used once, or at least in a limited capacity

Discuss the use of the Unclassified letter 'X'. A good description can be found on page 39 & 40 in the Meier textbook.

## Symbology – Building Blocks

- Circles (Bubbles)
- Squares & Rectangles
- Triangles
- Half Circles
- Lines

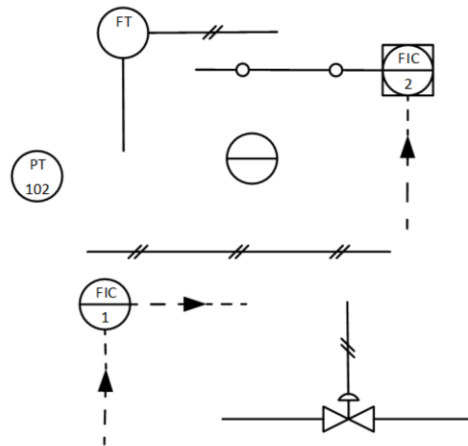

Discuss the use of the basic geometric shapes as per chapter 02 in the textbook.

Students will most likely not know what most of the instruments are as of yet, nor will they have a good understand of the tagging and identifiers; however, provide a brief introduction to them, with much more to come in this and the next several chapters, and relate them to as many instruments on the lab trainers as time permits.

## Instrument Location Information

- ISA standard instrument symbols, location and accessibility
- Symbols are used to help identify the type of:
  - Instrument
  - Location
    - Located in the field
    - Not panel, console or cabinet mounted
    - Visible at the field location
    - Accessible to the operator
    - Located in or on front of central or main console or panel
    - Visible on front panel
    - Location at rear of main or central panel
    - Not accessible to the operator

Review the various instrument mounting locations with students before proceeding to the next slides that show the symbols.

## Instrumentation Devices or Function Symbols

### Field Mounted



Discrete  
Instruments



Computer  
Systems  
And  
Software



Alternate  
Choice  
Or  
Safety  
Instrumented  
System



Primary  
Choice  
Or  
Basic  
Process  
Control  
System

Discuss the symbols on the next several slides

- Located in field
- Not panel, console or cabinet mounted
- Visible at the field location
- Accessible to the operator

Review the table found on page 46 of the textbook and/or Table 5.1.1 on page 36 of the ANSI/ISA-5.1-2009 Standard

## Instrumentation Devices or Function Symbols

Normally Accessible to Operator



Discrete  
Instruments



Computer  
Systems  
And  
Software



Alternate  
Choice  
Or  
Safety  
Instrumented  
System



Primary  
Choice  
Or  
Basic  
Process  
Control  
System

Discuss these symbols

- Located in or on front of main or central console or panel
- Visible on the front of panel or on video display
- Normally accessible to the operator at the front console or panel

Review the table found on page 46 of the textbook and/or Table 5.1.1 on page 36 of the ANSI/ISA-5.1-2009 Standard



## Instrumentation Devices and Function Symbols

Normally inaccessible to the operator or behind-the-panel devices or functions



Discrete  
Instruments



Computer  
Systems  
And  
Software



Alternate  
Choice  
Or  
Safety  
Instrumented  
System



Primary  
Choice  
Or  
Basic  
Process  
Control  
System

Discuss these symbols

- Located in the rear of the main or central panel
- Located in cabinet behind the panel
- Not visible on the front of the panel or on a video display
- Not normally accessible by the operator at the console or panel

Review the table found on page 46 of the textbook and/or Table 5.1.1 on page 36 of the ANSI/ISA-5.1-2009 Standard

## Instrumentation Devices and Function Symbols

Auxiliary location normally accessible to the operator



Discrete  
Instruments



Computer  
Systems  
And  
Software



Alternate  
Choice  
Or  
Safety  
Instrumented  
System



Primary  
Choice  
Or  
Basic  
Process  
Control  
System

Discuss these symbols

- Located in or on front of secondary or local console or panel
- Visible on the front panel or on a video display
- Normally accessible to the operator at the front console or panel

Review the table found on page 46 of the textbook and/or Table 5.1.1 on page 36 of the ANSI/ISA-5.1-2009 Standard

## Instrumentation Devices and Function Symbols

Normally inaccessible to the operator or behind-the-panel devices or functions



Discrete  
Instruments



Computer  
Systems  
And  
Software



Alternate  
Choice  
Or  
Safety  
Instrumented  
System



Primary  
Choice  
Or  
Basic  
Process  
Control  
System

Discuss these symbols

- Located in the rear of the secondary or local panel
- Located in a field cabinet
- Not visible on the front of the panel or on a video display
- Not normally accessible to the operator at the console or the panel

Review the table found on page 46 of the textbook and/or Table 5.1.1 on page 36 of the ANSI/ISA-5.1-2009 Standard

## Instrumentation Devices and Function Symbols



Instrument  
With  
Long Tag  
Number



Instruments  
Sharing  
Common  
Housing \*



Purge or  
Flush  
Device \*\*



Rest for  
Latch-Type  
Actuator \*\*

\* It is not mandatory to show a common housing

\*\* These diamonds are approximately half the size of the larger ones

The next two slide are a sample of additional symbols. Discuss some of the other symbols that are not referenced in the textbook but can be found on page 37 in Table 5.1.2 and on page 38 in Table 5.2.1 in the ANSI/ISA-5.1-2009 Standard

## Instrumentation Devices and Function Symbols



Undefined  
Interlock  
Logic \*\*\*



Panel  
Mounted  
Patchboard  
Point 12



Diaphragm  
Seal





Pilot  
Light

\*\*\* For specific logic symbols, see ANSI/ISA Standard S5.2

Discuss some of the other symbols that are not referenced in the textbook but can be found on page 37 in Table 5.1.2 and on page 38 in Table 5.2.1 in the ANSI/ISA-5.1-2009 Standard

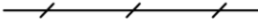
## Instrument Line Symbols

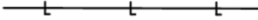
Instrument Supply Or Connection to Process	
Undefined Signal	
Pneumatic Signal	
Electrical Signal	
Hydraulic Signal	

Discuss the line types on the next several slides as found in the textbook in Table 2-13 on pages 48 & 49 and in Table 5.3.2 on pages 46 & 47 in the ANSI/ISA-5.1-2009 Standard.

Click the slide to display the note for the single asterisk.

Click the slide to return to the line types.

Click the slide to display the note for the two asterisks.

Click the slide to return to the line types.

Click the slide to advance.

## Instrument Line Symbols

Capillary Tube

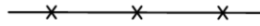

Electromagnetic or Sonic  
Signal (Guided) \*\*\*



Electromagnetic or Sonic  
Signal (Not Guided) \*\*\*



Internal System Link  
(Software or Data Link)

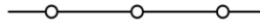

\*\*\* Electromagnetic phenomena include heat, radio waves, nuclear radiation, and light.

Continue discussing line symbols

## Instrument Line Symbols

Mechanical Link



Optional Binary (ON – OFF) Symbols

Pneumatic Binary Signal

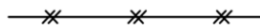

Electric Binary Signal



Continue discussing line symbols



## Final Control Elements - Valves



- Generic Two-way
- Straight globe
- Gate



- Generic Two-way
- Straight globe
- Gate



Ball Valve



Screw-down



Generic 2-Way



Powered



Generic Two-Way  
Angle



Generic 3-Way



Generic 4-Way

Students will not know the different types of valves at this time. Point out that valves are simply a bow-tie symbol with add-ons that make the valve representative of what type of valve it is. Use the valves in the lab to demonstrate what they physically look like. There might not be a sample of all the valve types.

Refer the students to Pages 48 through 55 of the ANSI/ISA-5.1-2009 Standard for more final control elements.

The next slide shows some pressure relief valve symbols.

## Final Control Elements - Valves

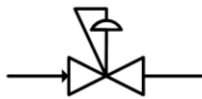

Backpressure regulator, Internal pressure tap

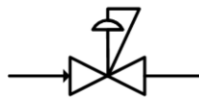

Pressure-reducing regulator, Internal pressure tap

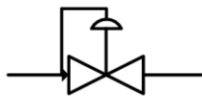

Backpressure regulator, External pressure tap

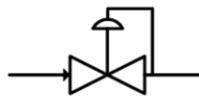

Pressure-reducing regulator, External pressure tap



Generic pressure safety valve, Pressure relief valve

Students will not know the different types of valves at this time. Point out that valves are simply a bow-tie symbol with add-ons that make the valve representative of what type of valve it is. Use the valves in the lab to demonstrate what they physically look like. There might not be a sample of all the valve types.

Refer the students to Pages 48 through 55 of the ANSI/ISA-5.1-2009 Standard for more final control elements.

## Primary Flow Measurement - Flowmeters



Standard Pitot Tube



Turbine, Propeller



Vortex Shedding



Magnetic 01



Magnetic 02



Positive Displacement



Variable Area

Flow is a common measurement that is made in process control. There are many different types of flowmeters and methods of measuring flow. Shown on this slide are just a few.

As before, the students will not have a knowledge of flow and flowmeters. Use the lab equipment when possible to show the physical device(s).

The next slide is from the textbook and shows the P&ID for various methods of measuring flow by using differential pressure.

## Differential Pressure - Flowmeters

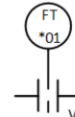
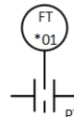
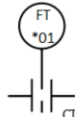
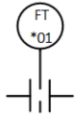

Single connection. The CT = Corner Tap, PT = Pipe Tap, VC = Vena Contracta Taps. These three are not very common.

Double connections to the process. PT = Pipe Tap, VC = Vena Contracta Taps.

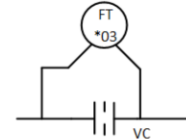
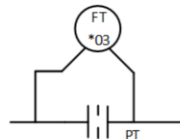
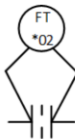

<http://www.pipingguide.net/2009/06/types-of-pressure-taps.html>

Students will not know about differential flow at this time. Give a brief explanation of what an orifice plate flowmeter is and how, by measuring the pressure on either side, (differential pressure), a value for flow can be achieved.

For more information on the types of taps used in orifice plate flowmeters, visit this website: <http://www.pipingguide.net/2009/06/types-of-pressure-taps.html>

There will much more on all of these and other processes and measurements in upcoming course work.

## Pneumatic Control Loop

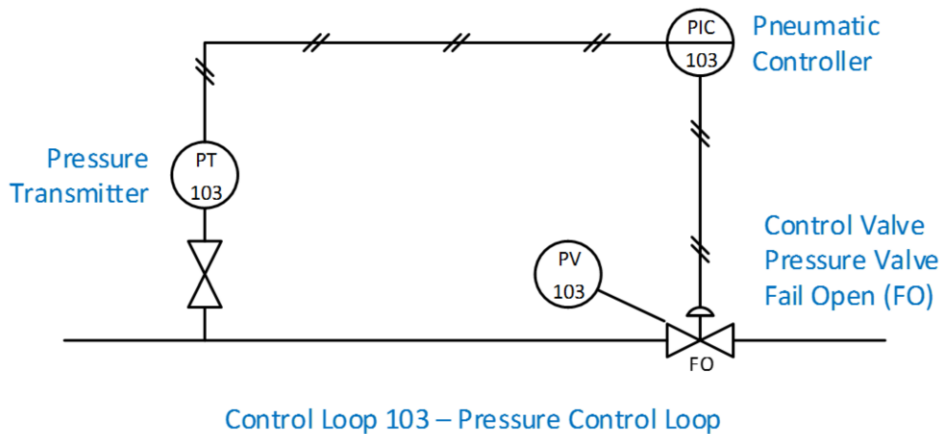

Review this simple pressure control loop.

Identify the transmitter measuring the pressure. There is a generic valve that can be used to remove the pressure transmitter from the loop.

Identify the PIC as a pressure indicator controller that supplies a 3-15 psig out to control the valve.

Identify the pressure control valve, PV, as a Fail Open (FO).

Identify the symbols for major pipes, and pneumatic signals

Students will not know much of anything about this diagram; however, after explaining to them what it is and how it functions, poll the class as to if there is anything missing? (See page 35 in the text).

Items that could be included that are not:

- Air sets
- Setpoints

- Root drive
- Control valve size
- Valve positioner
- Controller location

## Valve Failures

- Valves can fail in various positions
  - Fail Open (FO)
  - Fail Closed (FC)
  - Fail Locked (FL)
  - Fail in Last Position, Drift Open (FL/DO)
  - Fail in Last Position, Drift Closed (FL/DC)
- Valves are shown on a P&ID by a shape that resembles a bow tie
- Actuators are shown with a line from the bow tie junction to a shape such as a half circle, a square, a horizontal line, etc. (More on valve symbols later in the chapter.)
- The next slide shows symbols for valve failures

Discuss the failure modes that can occur in valves with some examples. Such as, a drain valve on a vessel filled with toxic material would want to fail closed so that none of the toxic materials will escape the vessel.

Also mention that the symbols vary on the type of valve and how it is controlled and that valves will be covered later in the chapter.

## Valve Failures - Symbols

Method A

Method B



Fail to open position



Fail to closed position



Failed to last position



Fail to last position, Drift open



Fail to last position, Drift closed

**NOTE:**

1. Users engineering a design standards, practices, and/or guidelines shall document which symbols have been selected.

2. The symbols are applicable to all types of control valves and actuators.

From ANSI/ISA-5.1-2009 page 34

Click the image to enlarge. A PDF file will open.

Discuss the standard symbols used for valve failure identification.

The notes come from the ANSI/ISA-5.1-2009 Standard page 34



## Electronic Control Loop

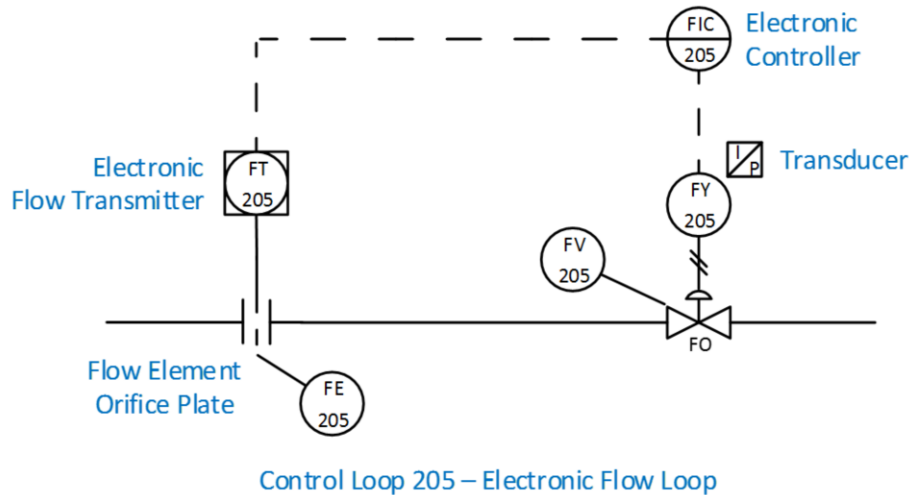

Review this simple Electronic control loop.

Identify the instruments, pipes and line types.

Identify the control valve, FV, as a Fail Open (FO).

Students will not know much of anything about this diagram; however, explaining to them what it is and how it functions. *(See page 36 in the text).*

FT – Flow Transmitter

FE – Flow Sensor Primary Element

FIC – Flow Indicator Controller

FY – Flow Transducer I/P

FV – Flow Valve