

Electrical Level 3



Distribution Equipment 26306-14



Objectives

When trainees have completed this lesson, they should be able to do the following:

1. Describe the purpose of switchgear.
2. Describe the four general classifications of circuit breakers and list the major circuit breaker ratings.
3. Describe switchgear construction, metering layouts, wiring requirements, and maintenance.
4. List *National Electrical Code*[®] (*NEC*[®]) requirements pertaining to switchgear.
5. Describe the visual and mechanical inspections and electrical tests associated with low-voltage and medium-voltage cables, metal-enclosed busways, and metering and instrumentation.
6. Describe a ground fault relay system and explain how to test it.

This is a knowledge-based module; there are no Performance Tasks.



1.0.0 – 3.5.0

Introduction; Voltage Classifications; Switchboards

- Switchgear is classified first by method of construction and second by its voltage rating.
- Switchboards are constructed of a single panel, frame, or assembly of panels on which switches, protective devices, buses, and instruments may be mounted. Switchboards have specific bus spacing requirements to prevent overheating of the frame.

Amperes	Minimum Distance from Phase Bus to Closest Steel Member	Minimum Distance from Neutral Bus to Closest Steel Member
3,000	4"	2"
4,000	6"	3"
5,000 and over	12"	see below
5,000 to 6,000	An aluminum or nonmagnetic material should be used in place of steel frame sections. Wherever possible, you must maintain 12" to steel members and 6" to aluminum or nonmagnetic members. Neutral spacing can be 6" and 3", respectively. If the main bus is tapered, it is permissible (at 4,000A and below) to use steel frames for those sections containing the tapered bus.	
6,000 and over	You must use an aluminum or nonmagnetic material for frame sections and maintain 12" to steel members and 6" to aluminum or nonmagnetic members. Neutral spacing can be 6" and 3", respectively. The use of any steel frame members is discouraged. If the main bus is tapered, it is permissible (at 4,000A and below) to use steel frames for those sections containing the tapered bus.	

Note: For amperages above 8,000A, the neutral spacing must be 12" wherever possible.



1.0.0 – 3.5.0

Typical Busbar Spacing Requirements

VOLTAGE INVOLVED		MINIMUM SPACING BETWEEN LIVE PARTS OF OPPOSITE POLARITY		MINIMUM SPACING THROUGH AIR AND OVER SURFACE BETWEEN LIVE PARTS AND GROUNDED METAL PARTS
GREATER THAN	MAX.	THROUGH AIR	OVER SURFACE	BOTH THROUGH AIR AND OVER SURFACE
0	- 125	1/2"	3/4"	1/2"
125	- 250	3/4"	1 1/4"	1/2"
250	- 600	1"	2"	*1"

* A through air spacing of not less than 1/2" is acceptable (1) at a molded-case circuit breaker or a switch other than a snap switch, (2) between uninsulated live parts of a meter mounting or grounded dead metal, and (3) between grounded dead metal and the neutral of a 480Y/277V, three-phase, four-wire switchgear section.

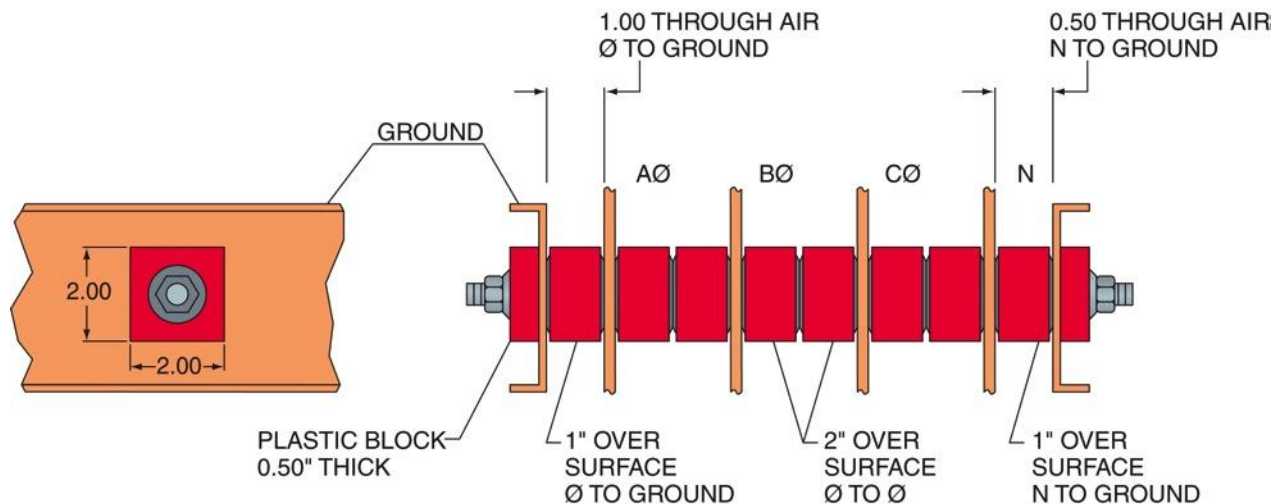

26306-14_F01.EPS

4.0.0 – 4.5.0

Switchgear

- Switchgear provides a means of switching/disconnecting power system apparatus and provides power system protection by automatically isolating faulty components.
- Switchgear can be classified as metal-enclosed switchgear (low voltage), metal-clad switchgear (low and medium), metal-enclosed interrupters, and unit substations.



26306-14_F02.EPS

4.0.0 – 4.5.0

Medium-Voltage, Metal-Clad Switchgear (Exterior View)

- Switchgear consists of one or more cubicles that are mechanically and electrically connected to create a single coordinated installation.
- Switchgear enclosures are constructed of heavy sheet steel with structural members across the top, sides, and bottom.



26306-14_F03.EPS



4.0.0 – 4.5.0

Next Session... Medium-Voltage, Metal-Clad Switchgear (Interior View)

- Metal-clad switchgear enclosures are divided into three sections: the front section, the bus section, or termination section.
- Switchgear sections are separated using metal partitions to confine damage if a fault should occur. The strength of the enclosure or mounting system depends on its intended use.

Testing and Maintenance; **NEC® Requirements**



26306-14_F04.EPS



5.0.0 – 5.2.6

Testing and Maintenance; *NEC*[®] Requirements

Minimum Voltage Rating of Equipment	Minimum Test Voltage (VDC)	Recommended Minimum Insulation Resistance (in Megohms)
2–250V	500	50
251–600V	1,000	100
601–5,000V	2,500	1,000
5,001–15,000V	2,500	5,000
15,001–39,000V	5,000	20,000

- Switchgear requires regular testing and maintenance to ensure the mechanical and electrical integrity of the equipment.
- Insulation resistance tests are taken on each bus section (phase-to-phase and phase-to-ground) for one minute.
- Test values vary depending on whether it is an acceptance test or a maintenance test. Typical acceptance test values are shown here.



5.0.0 – 5.2.6

Infrared Imager Used in Thermographic Surveys

- Thermographic surveys are used to locate temperature gradients in electrical equipment that may indicate potential faults.
- These tests are conducted while the equipment is energized and may only be performed by qualified personnel.



26306-14_F05.EPS

5.0.0 – 5.2.6

Overpotential DC Test Voltages for Electrical Apparatus Other than Inductive Equipment

Nominal Voltage Class	DC Test Voltage Max.	
	New	Used
250V	2,500VDC	1,500VDC
600V	3,500VDC	2,000VDC
5,000V	18,000VDC	11,000VDC
15,000V	50,000VDC	30,000VDC

- During electrical testing, overpotential readings are taken on each bus section (phase-to-ground) for one minute.
- Typical overpotential DC acceptance test voltages are shown here. Maintenance values will vary by equipment manufacturer.



6.0.0 – 6.4.0

NEC[®] Requirements

- This switchgear had an unused opening that was left uncovered after the installation. A rodent entered the compartment, shorting out one of the busbars and causing extensive damage.
- **NEC Section 110.12(A)** requires that any unused openings be sealed equivalent to the structure wall.



26306-14_SA05.EPS

Ground Faults

- The three basic methods of sensing ground faults include the ground return method, the residual method, and the zero sequence method.
- The zero sequence method uses a special sensor to monitor all the phase conductors and the neutral conductor at the same time.

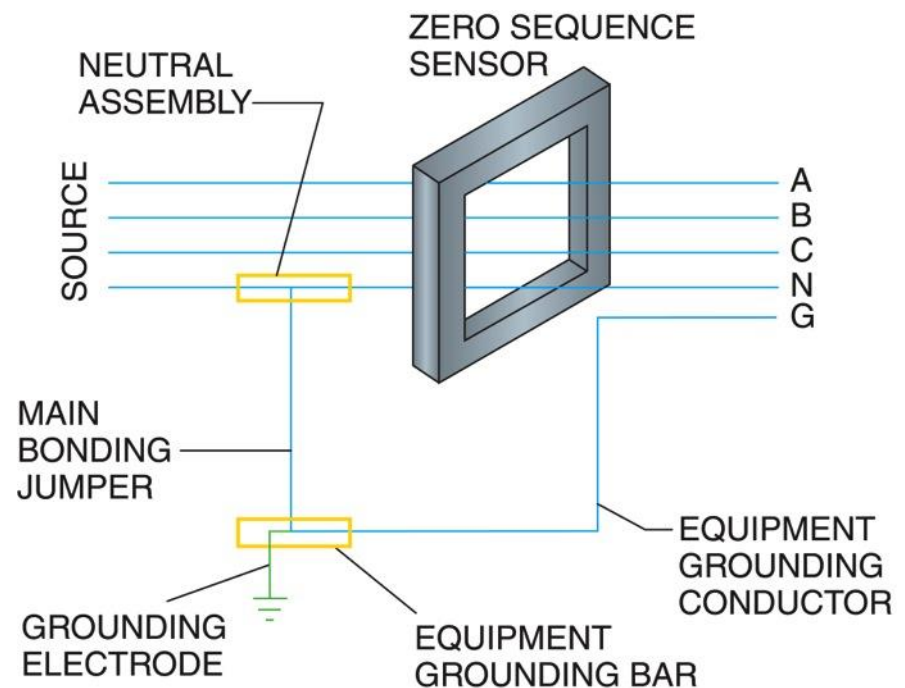

26306-14_F06.EPS

7.0.0 – 7.7.1

Next Session... Typical Wiring Diagram

- Wires from the sensor to the ground fault relay should be no longer than 25' and no smaller than No. 14 AWG.
- Wires from the ground fault relay to the trip coil should be no longer than 50' and no smaller than No. 14 AWG.

HVL Switch

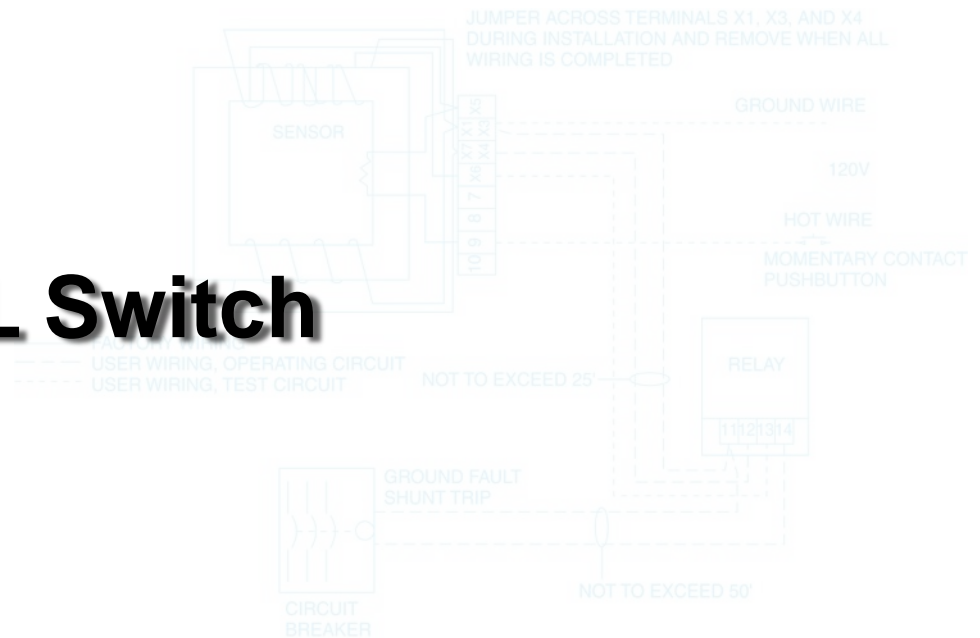

8.0.0 – 8.6.0

HVL Switch

- High-voltage limiting (HVL) switches are single-throw devices used to control primary circuits and are designed for use on systems between 2.4kV and 34.5kV.
- HVL switches may provide both switches and overcurrent protection, and are commonly used as a service disconnect in unit substations and medium-voltage feeder systems.



26306-14_F08.EPS

9.0.0 – 9.4.0

Bolted Pressure Switches

- Bolted pressure switches can be manual or motor-operated and offer a less expensive alternative to circuit breakers.
- Unlike a circuit breaker, they trip automatically in response to only three events: a ground fault, a phase failure, or a blown main fuse detector.

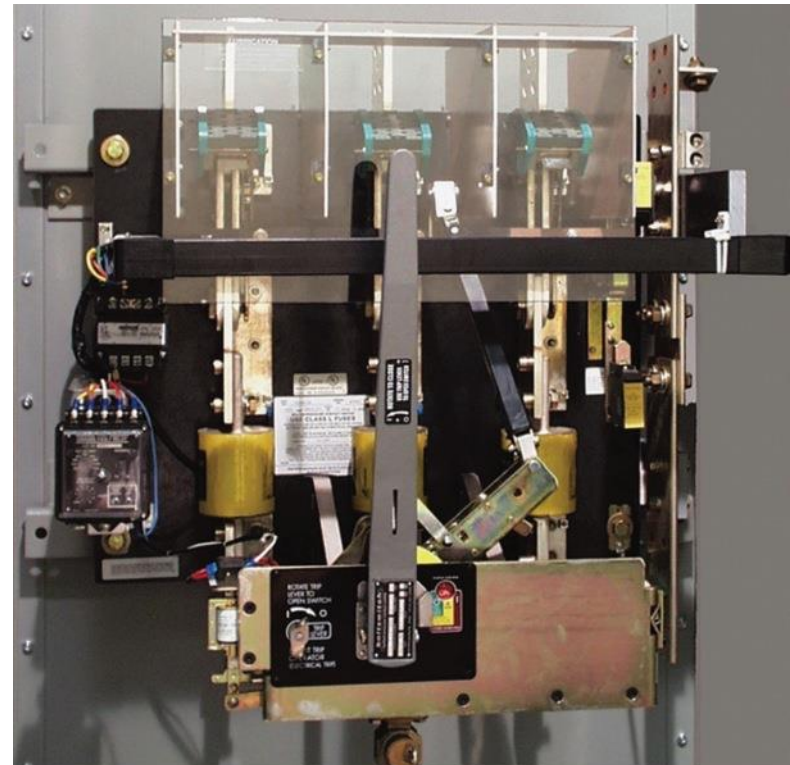

26306-14_F09.EPS

Switchgear

- Bolted pressure switches are used on service-entrance feeders in switchgear.
- These switches have a high failure rate due to lack of maintenance.



26306-14_F10.EPS

10.0.0 – 10.7.0

Next Session...Transformers

- Transformers are divided into two main categories: power transformers and distribution transformers. Power transformers step power down from transmission voltages to distribution voltages. Distribution transformers handle lower currents at lower voltage levels.
- Large transformers are usually oil-filled for better cooling and insulation. Dry transformers are used where oil-filled transformers would present a fire hazard.

Instrument Transformers; Circuit Breakers



26306-14_F11.EPS



11.0.0 – 12.1.0

Instrument Transformers; Circuit Breakers

- Instrument transformers reduce substation voltage and current levels to the lower levels required by relaying, metering, and other control circuits.
- There are two types of instrument transformers: potential transformers and current transformers.

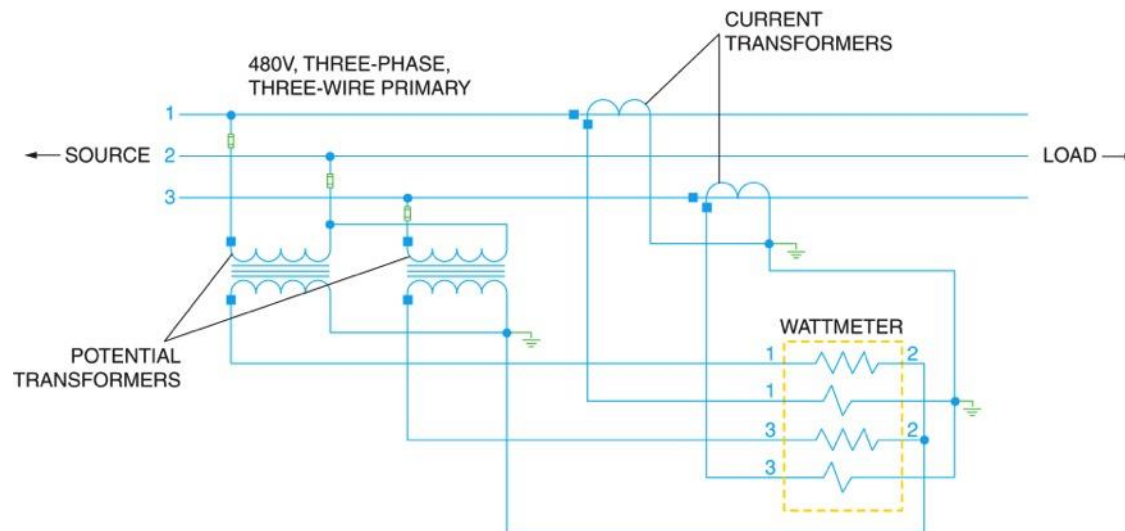

26306-14_F12.EPS



11.0.0 – 12.1.0

Potential Transformer Construction

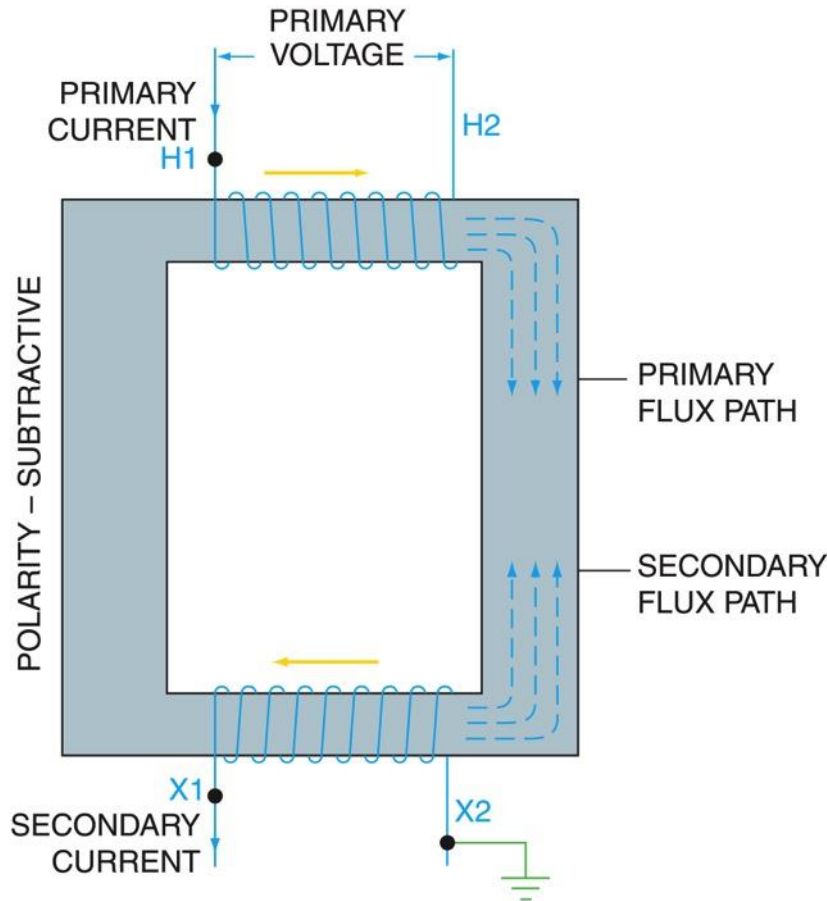

26306-14_F13.EPS

- A potential transformer is used to supply a voltage signal to various meters and protective relays.
- The secondary voltage of a potential transformer is typically 120V.

Types of Current Transformer Construction

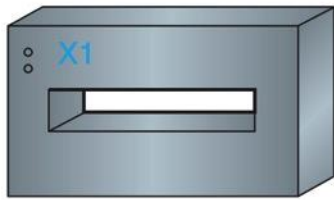

WINDOW TYPE

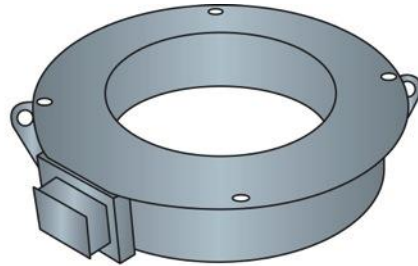

BUSHING TYPE

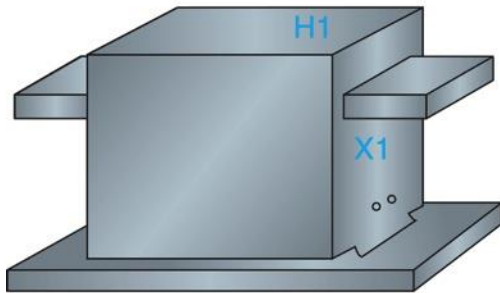

BAR TYPE

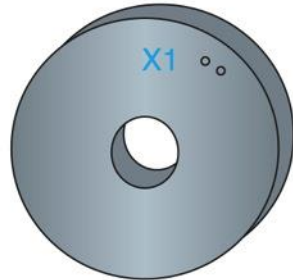

DONUT TYPE

26306-14_F14.EPS

- A current transformer is used to supply current to an instrument connected to its secondary. The secondary current of a current transformer is typically 5A.
- Never fuse a current transformer. If the secondary circuit is open, the primary current will produce a dangerously high voltage across both windings.

13.0.0 – 13.1.0

Electrical Drawing Identification

- Symbols and abbreviations are used to indicate the components on an electrical drawing and often vary by company. Always review the legend for the specific drawing in use.
- A control relay and its associated contacts are shown here.

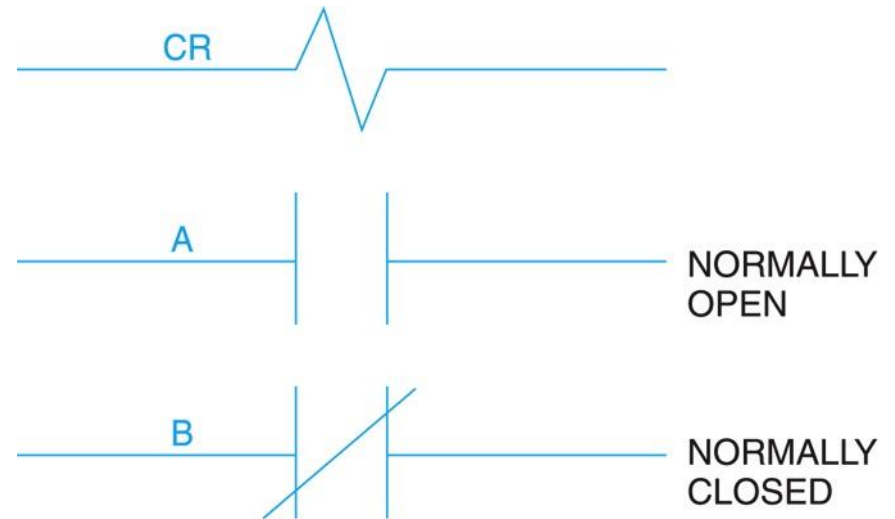

26306-14_F15.EPS

13.0.0 – 13.1.0

Switch Development

- In this control switch, contacts 1 through 4 open and close as a result of the operation of control switch 1 (CS1).
- In the Stop position, contact 2 is closed and the red lamp is lit. In the Start position, contacts 3 and 4 are closed, energizing the M coil and amber lamp. In the Run position, contact 4 opens, closing contact 1 and energizing the green lamp.

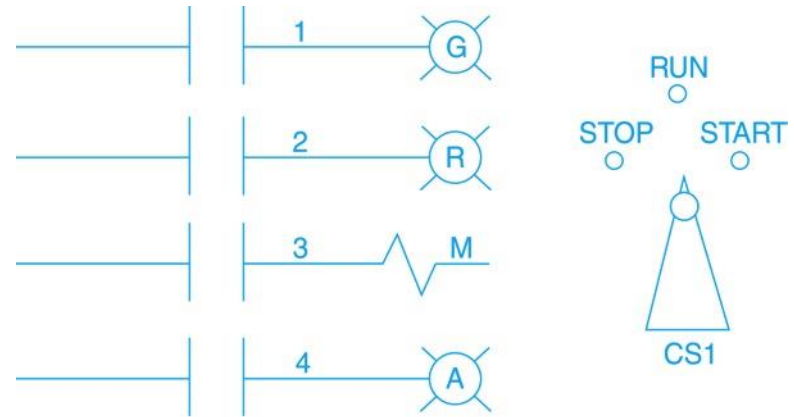













CONTACTS	STOP	RUN	START	
		X		CS1
	X			
		X	X	
			X	
SPRING RETURN			←	

X-SHUT

26306-14_F16.EPS

13.0.0 – 13.1.0

Next Session... Supplementary Contact Symbols

SPST NO		SPST NC		SPDT		TERMS
SINGLE BREAK	DOUBLE BREAK	SINGLE BREAK	DOUBLE BREAK	SINGLE BREAK	DOUBLE BREAK	
						SPST SINGLE-POLE SINGLE-THROW
DPST NO		DPST NC		DPDT		SPDT SINGLE-POLE DOUBLE-THROW
SINGLE BREAK	DOUBLE BREAK	SINGLE BREAK	DOUBLE BREAK	SINGLE BREAK	DOUBLE BREAK	DPST DOUBLE-POLE SINGLE-THROW
						DPDT DOUBLE-POLE DOUBLE-THROW
						NO NORMALLY OPEN
						NC NORMALLY CLOSED

Electrical Prints

26306-14_F17.EPS



14.0.0 – 14.4.2

Electrical Prints

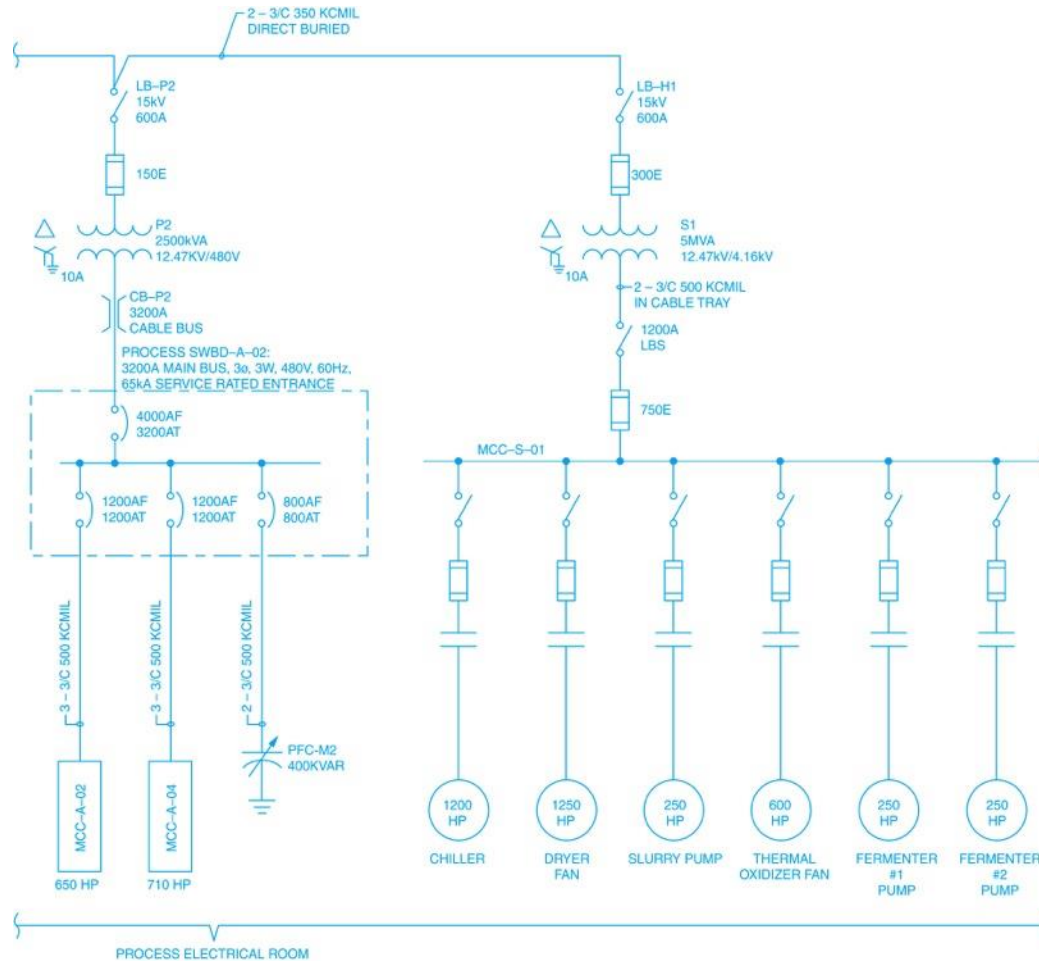

26306-14_F18.EPS



14.0.0 – 14.4.2

Elementary Schematic Diagram

- Elementary diagrams are more complex than simple one-line diagrams but less complex than schematic diagrams.
- Elementary diagrams show how each conductor is connected in the circuit, and also show the control wiring required to achieve the sequence of operations.

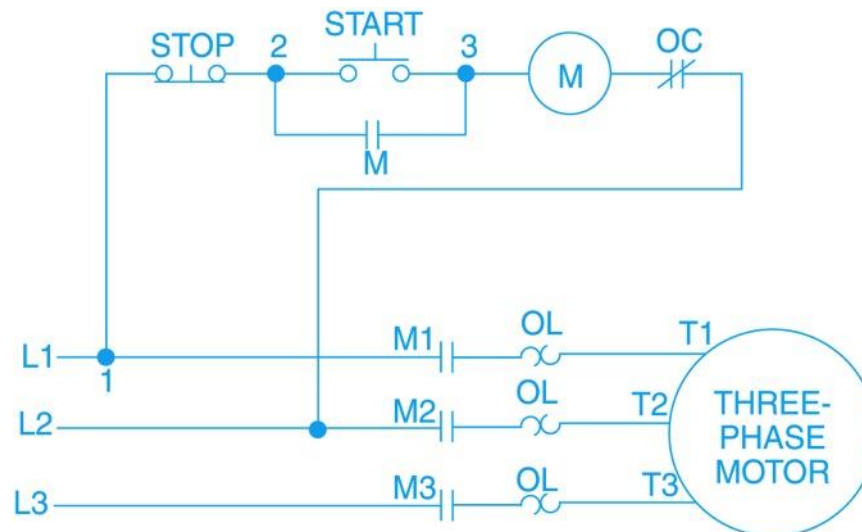

26306-14_F19.EPS



14.0.0 – 14.4.2

Point-to-Point Connection Diagram

- Connection diagrams show the internal connections between the components of an assembly or piece of equipment. Unlike an interconnection diagram, connection diagrams do not show external connections between assemblies or pieces of equipment.
- Point-to-point diagrams show each individual wire and its termination.

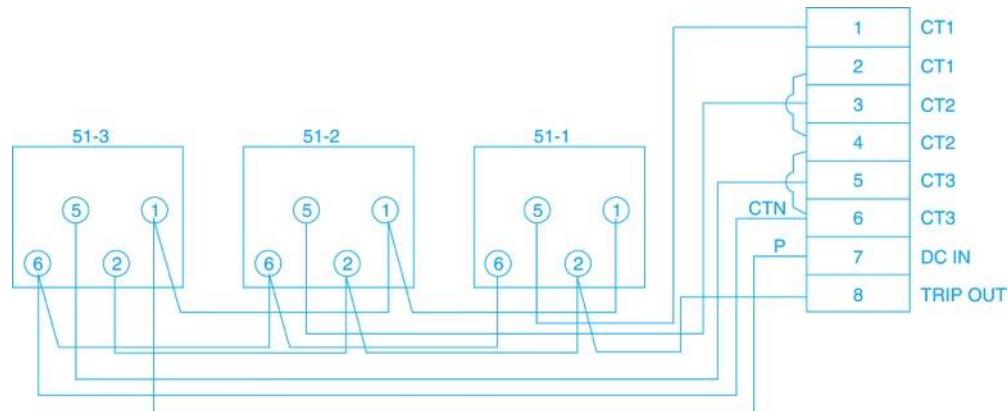

26306-14_F20.EPS



14.0.0 – 14.4.2

Cable Connection Diagram

- Complex systems may be drawn showing cables rather than individual conductors.
- Cable connection diagrams provide enough information to route the cable, but not enough information to make the terminations.

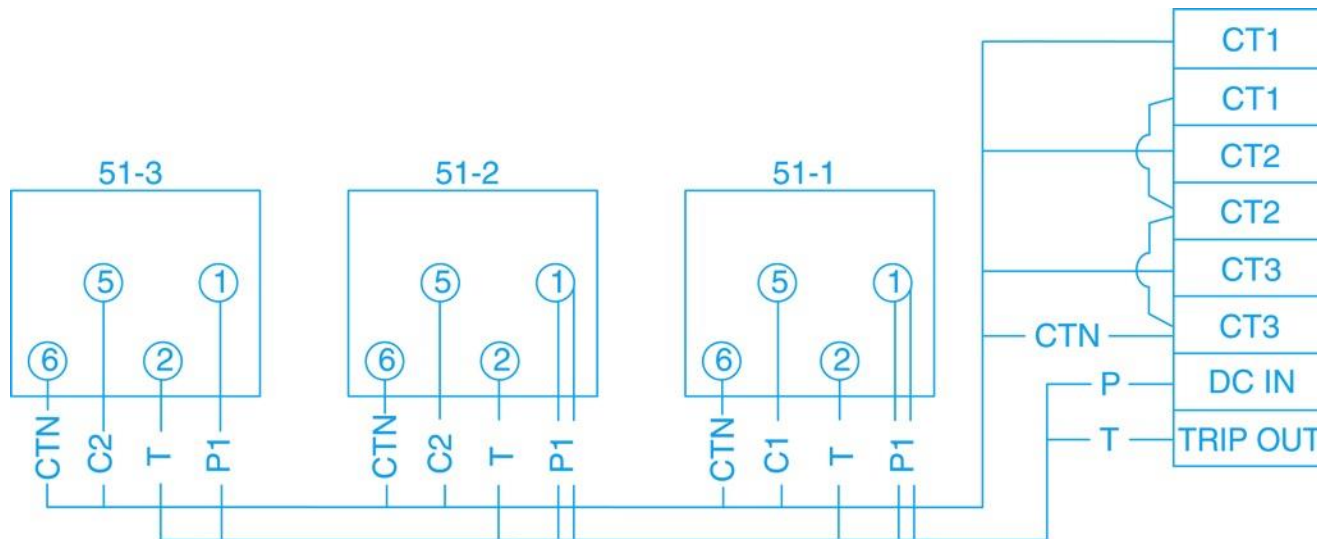

26306-14_F21.EPS



15.0.0 – 15.1.0

Manufacturer Drawings

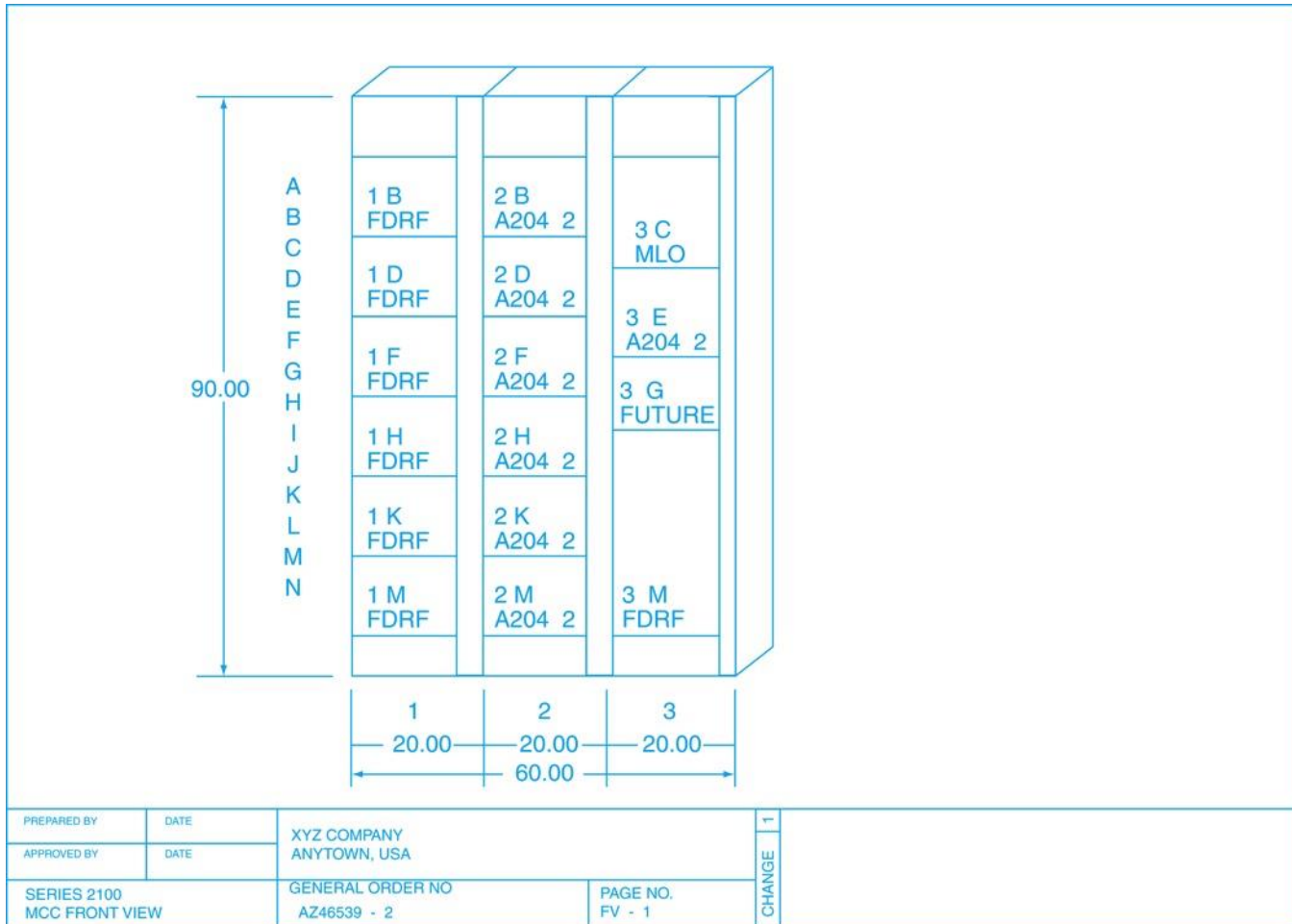

26306-14_F22.EPS



15.0.0 – 15.1.0

Motor Control Center Standard Unit Wiring Diagram

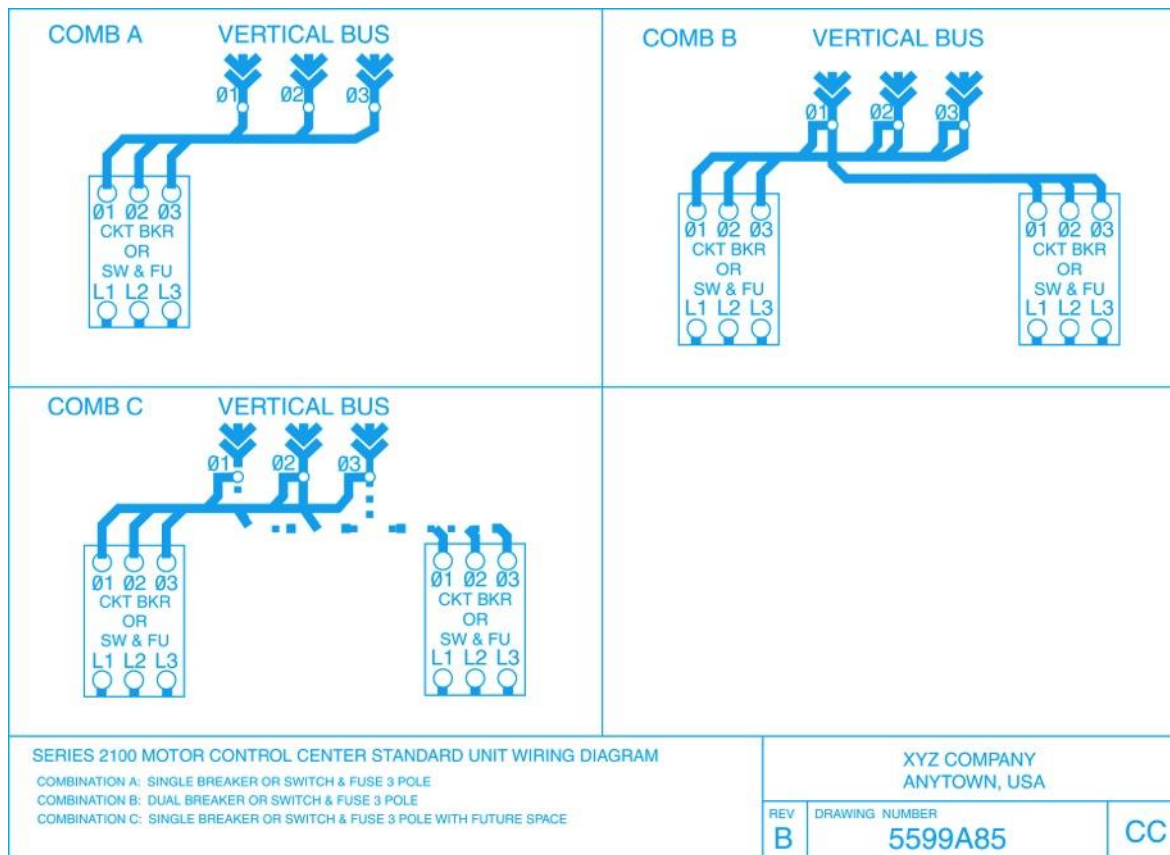

26306-14_F23.EPS



15.0.0 – 15.1.0

Unit Diagrams for Motor Control Center

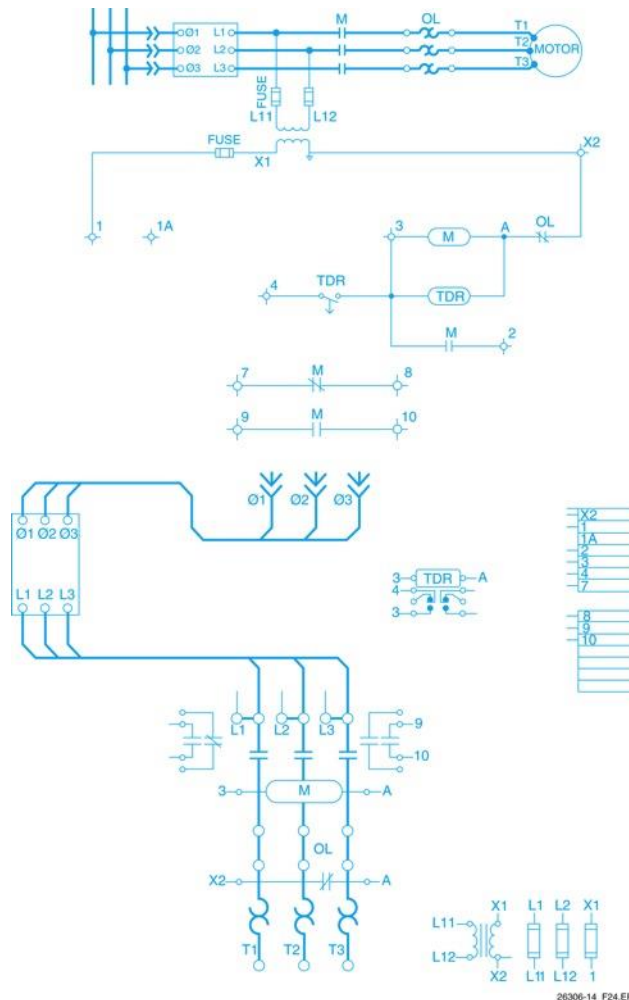

26306-14_F24.EPS



Panelboards

PANEL NO.	LOCATION	MAINS	VOLTAGE RATING	NO. OF CIRCUITS	BREAKER RATINGS	POLES	PURPOSE
P-1	BASEMENT N. CORRIDOR	BREAKER 100A	208/120V 3Ø, 4W	19 2 5	20A 20A 20A	1 2 1	LIGHTING AND RECEPTACLES SPARES
P-2	BASEMENT N. CORRIDOR	BREAKER 100A	208/120V 3Ø, 4W	24 2 0	20A 20A	1 2	LIGHTING AND RECEPTACLES SPARES
P-3	2ND FLOOR N. CORRIDOR	BREAKER 100A	208/120V 3Ø, 4W	24 2 0	20A 20A	1 2	LIGHTING AND RECEPTACLES SPARES
P-4	BASEMENT S. CORRIDOR	BREAKER 100A	208/120V 3Ø, 4W	24 2 0	20A 20A	1 2 1	LIGHTING AND RECEPTACLES SPARES
P-5	1ST FLOOR S. CORRIDOR	BREAKER 100A	208/120V 3Ø, 4W	23 2 1	20A 20A 20A	1 2 1	LIGHTING AND RECEPTACLES SPARES
P-6	2ND FLOOR S. CORRIDOR	BREAKER 100A	208/120V 3Ø, 4W	22 2 2	20A 20A 20A	1 2 1	LIGHTING AND RECEPTACLES SPARES
P-7	MFG. AREA S. WALL E.	BREAKER 100A	208/120V 3Ø, 4W	5 7 2	20A 20A 20A	1 1 1	LIGHTING AND RECEPTACLES SPARES
P-8	MFG. AREA S. WALL W.	BREAKER 100A	208/120V 3Ø, 4W	5 7 2	20A 20A 20A	1 1 1	LIGHTING AND RECEPTACLES SPARES
P-9	MFG. AREA S. WALL E.	BREAKER 100A	208/120V 3Ø, 4W	5 7 2	50A 20A 20A	1 1 1	LIGHTING AND RECEPTACLES SPARES
P-10	MFG. AREA S. WALL W.	BREAKER 100A	208/120V 3Ø, 4W	5 7 2	50A 20A 20A	1 1 1	LIGHTING AND RECEPTACLES SPARES
P-11	MFG. AREA EAST WALL	LUGS ONLY 225A	208/120V 3Ø, 4W	6	20A	3	BLOWERS AND VENTILATORS
P-12	BOILER ROOM	BREAKER 100A	208/120V 3Ø, 4W	10 4	20A 20A	1 1	LIGHTING AND RECEPTACLES SPARES
P-13	BOILER ROOM	LUGS ONLY 225A	208/120V 3Ø, 4W	6	20A	3	OIL BURNERS AND PUMPS
P-14	MFG. AREA EAST WALL	LUGS ONLY 400A	208/120V 3Ø, 4W	3 2 1	175A 70A 40A	3 3 3	CHILLERS FAN COIL UNITS FAN COIL UNITS
P-15	MFG. AREA WEST WALL	LUGS ONLY 600A	208/120V 3Ø, 4W	5	100A	3	TROLLEY BUSWAY AND ELEVATOR

26306-14_F25.EPS



Typical Panelboard



26306-14_F26.EPS

- The main feed busbars run the height of the panelboard.
- The buses to the branch circuit protective devices are connected to the alternate main buses.

16.0.0 – 16.4.0

Lighting and Appliance Branch Circuit Panelboard— Single-Phase, Three-Wire Connections

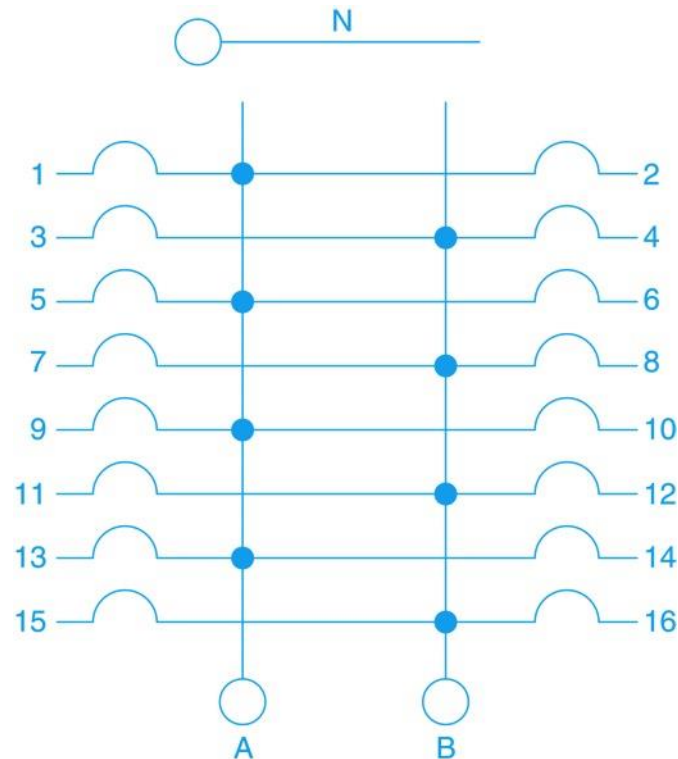

26306-14_F27.EPS



16.0.0 – 16.4.0

Lighting and Appliance Branch Circuit Panelboard—Three-Phase, Four-Wire Connections

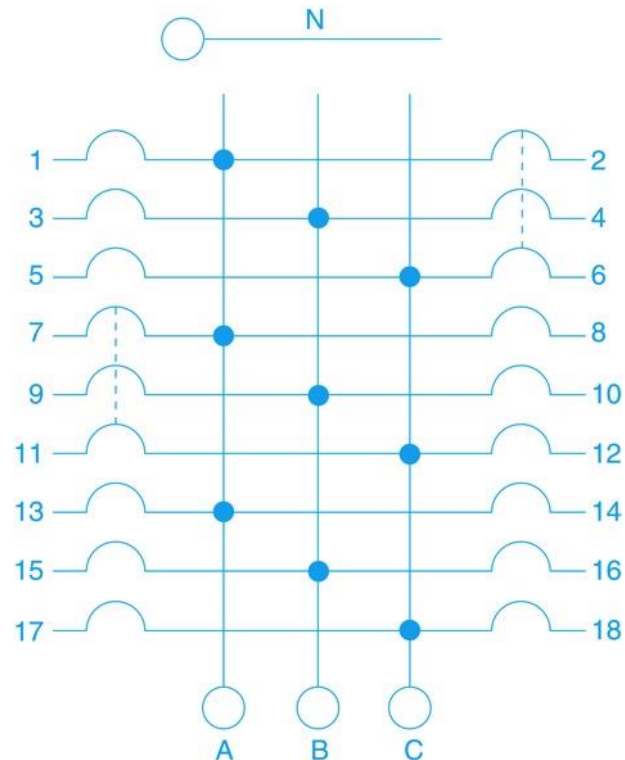

26306-14_F28.EPS



16.0.0 – 16.4.0

Bakery Panelboard Showing Alternate Numbering Scheme

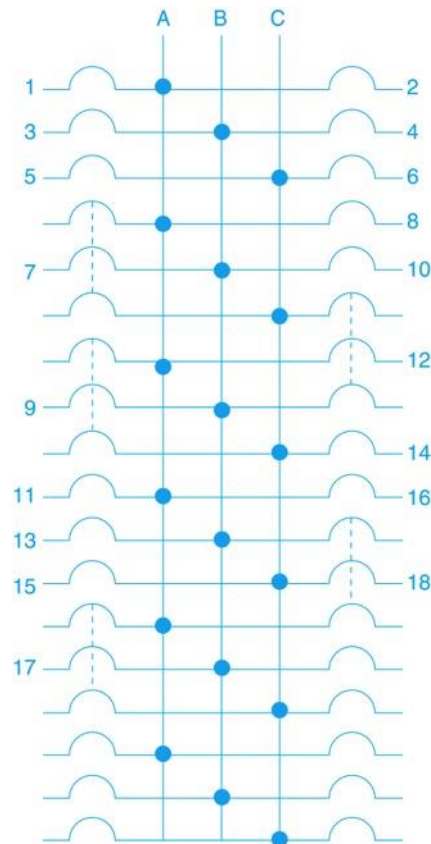

26306-14_F29.EPS



16.0.0 – 16.4.0

Panelboards and Switchboards Supplied by Four-Wire, Delta-Connected System

High leg B must be orange in color, tagged, or identified by other effective means.

NEC Section 110.15

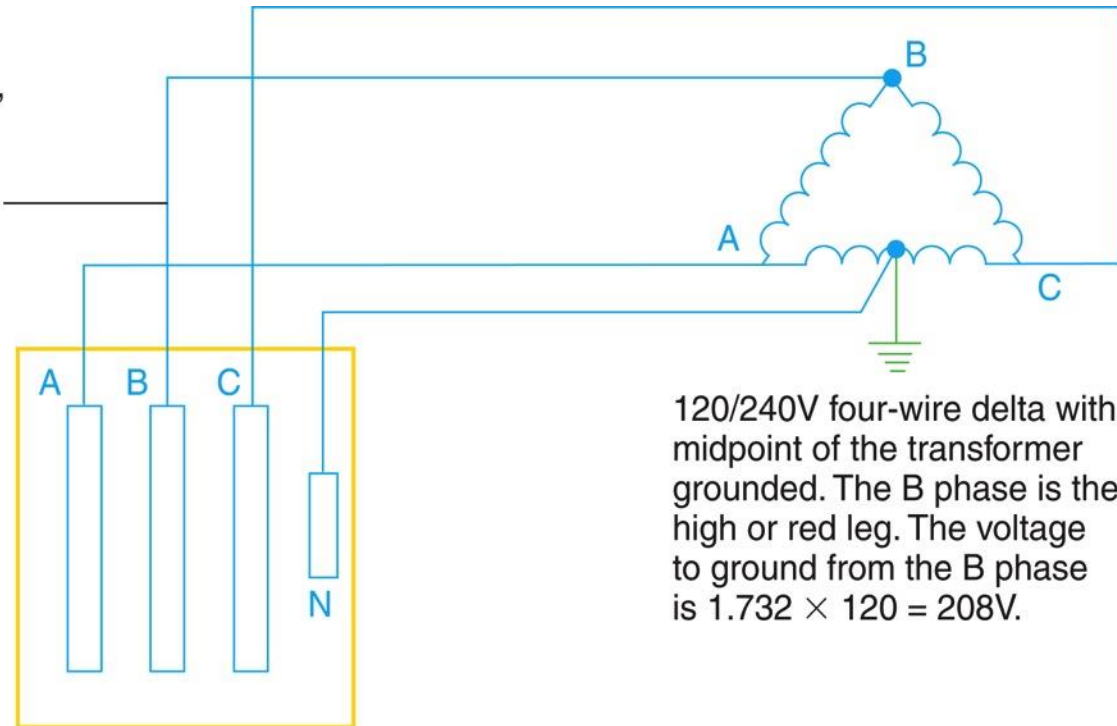

120/240V four-wire delta with midpoint of the transformer grounded. The B phase is the high or red leg. The voltage to ground from the B phase is $1.732 \times 120 = 208\text{V}$.

26306-14_F30.EPS

16.0.0 – 16.4.0

Circuit Breaker with Electronic Trip Unit

- Main circuit breakers used as the main protective devices are provided with an electronic trip unit that allows adjustments to the degree of protection provided.
- The trip must be set to the minimum practical setting and must be lower than the value of the short circuit current available at that point.

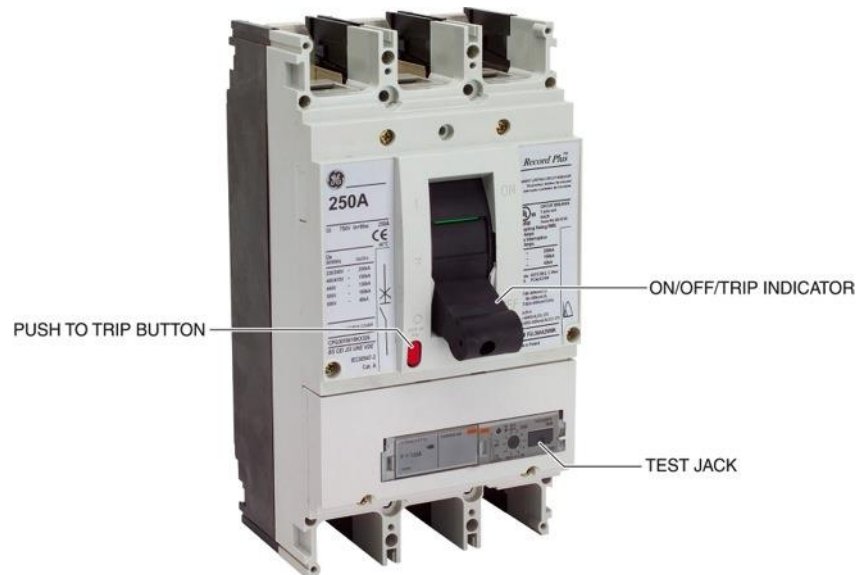

26306-14_F31.EPS



16.0.0 – 16.4.0

Branch Circuit Protective Devices

A double-pole breaker requires the same installation space as two single-pole breakers.



26306-14_F32.EPS



Wrap Up

3-2-1

- 3 – Write 3 important things learned during class
- 2 – Write 2 questions you have about the material
- 1 – Write 1 thought you had about the material



Next Session...

MODULE EXAM

Review the complete module to prepare for the module exam. Complete the Module Review as a study aid.

